

khun track by nelux

2025



6 Wires 3 Circuits DALI Track System 6线三回路DALI轨道系统	P04~P10
4 Wires Single Phase DALI Track System 4线单回路DALI轨道系统	P11~P15
4 Wires 3 Circuits Track System (Regular) 4线三回路轨道系统(常规款)	P16~P22
4 Wires 3 Circuits Recessed Track System (Regular) 4线三回路嵌入式轨道系统(常规款)	P23~P24
4 Wires 3 Circuits Track System (Deluxe) 4线三回路轨道系统(豪华款)	P25~P29
4 Wires 3 Circuits Recessed Track System (Deluxe) 4线三回路嵌入式轨道系统(豪华款)	P30~P32
3 Wires Single Phase Track System 3线单回路轨道系统	P33~P39
M20 Low Voltage Magnet Track System M20款低压磁吸轨道系统	P40~P48
M20 Low Voltage Magnet Track Lamp Kits M20款低压磁吸轨道灯具套件	P49~P50



About Us

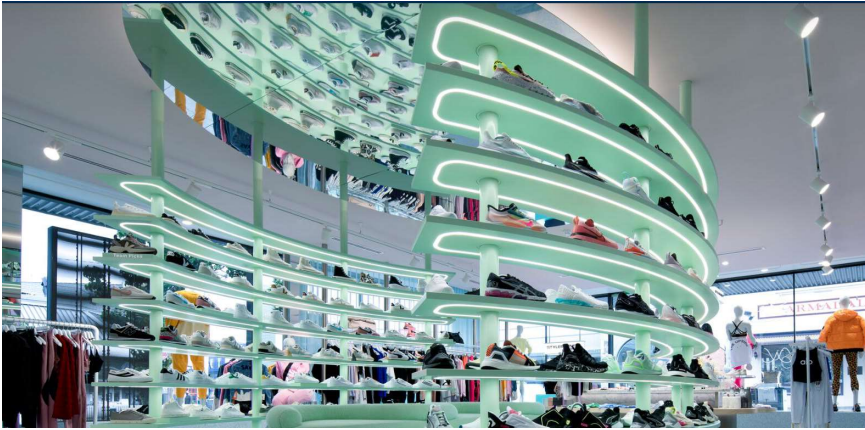

Nelux is a dedicated lighting track systems designer and distributor.

Premier quality has been always the objective Pursued by **Nelux**. Backed by a competent team with more than 15 years experiences in designing, engineering and manufacturing,

Nelux is able to provide high-end products for durable and reliable lighting applications. From isolator extrusion, plastic injection, shrapnel punching, manufacturing to assembly, we ensure the quality of every product and quick delivery services.

Our track systems are Rohs compliance, carried CE, TUV, SAA approval, CB and ENEC certified. Our key products are the Euro-stand 4 wires 3-circuit track system, regular and deluxe edition, 6 wires 3-circuit DALI and single phase DALI track system, Halo 3 wires single phase track system, and the 48V low voltage slim magnetic track system. Besides, Kehui can provide excellent OEM /ODM services on various types of non-standard track systems, curved track, showcase track etc.

Motivating by continuous improvement and endless pursuit of perfection, we value every possibility to provide quality products through cost effective options, which is enable us to offer high quality products with reasonable prices and satisfactory services to our customers.

6 Wires DALI Track System Application

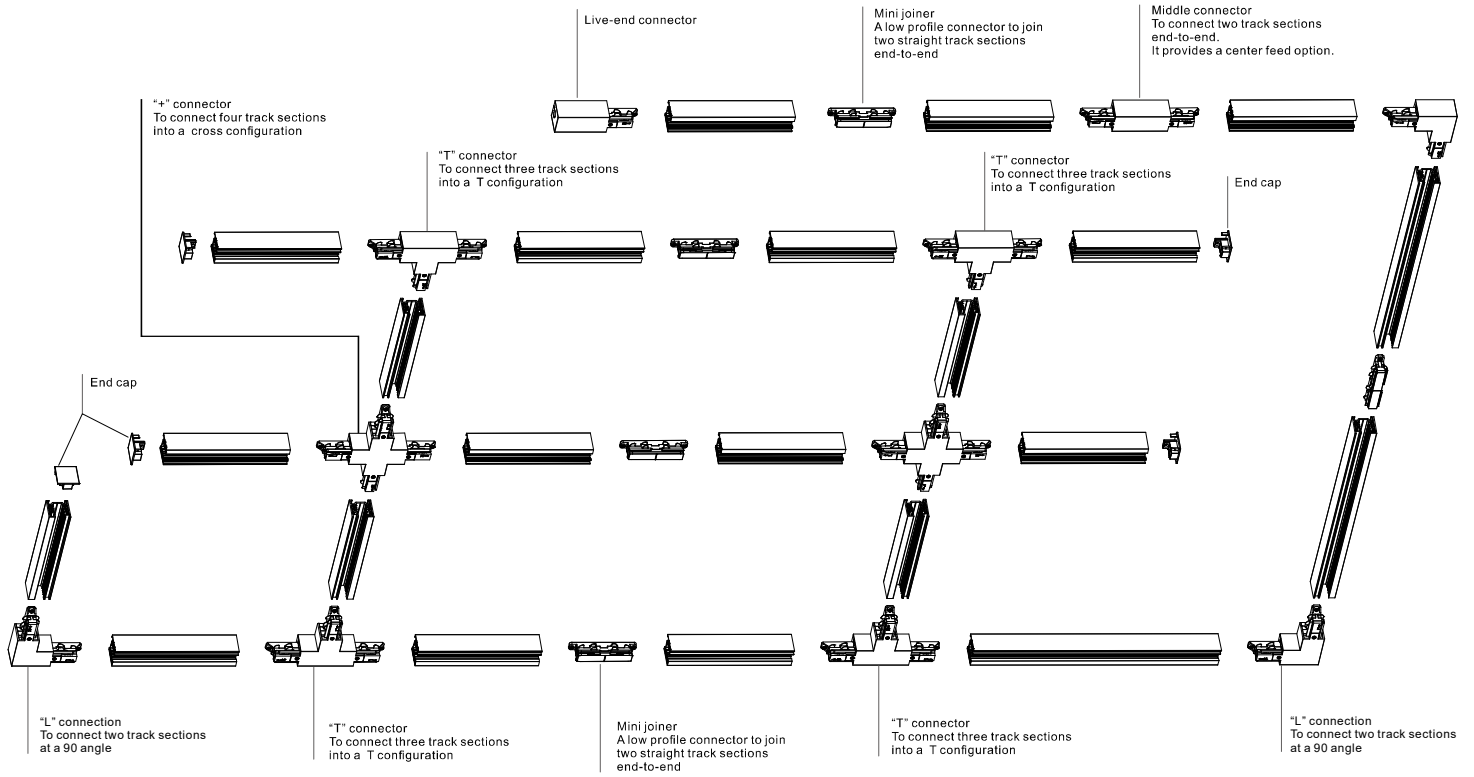

Connection Installation

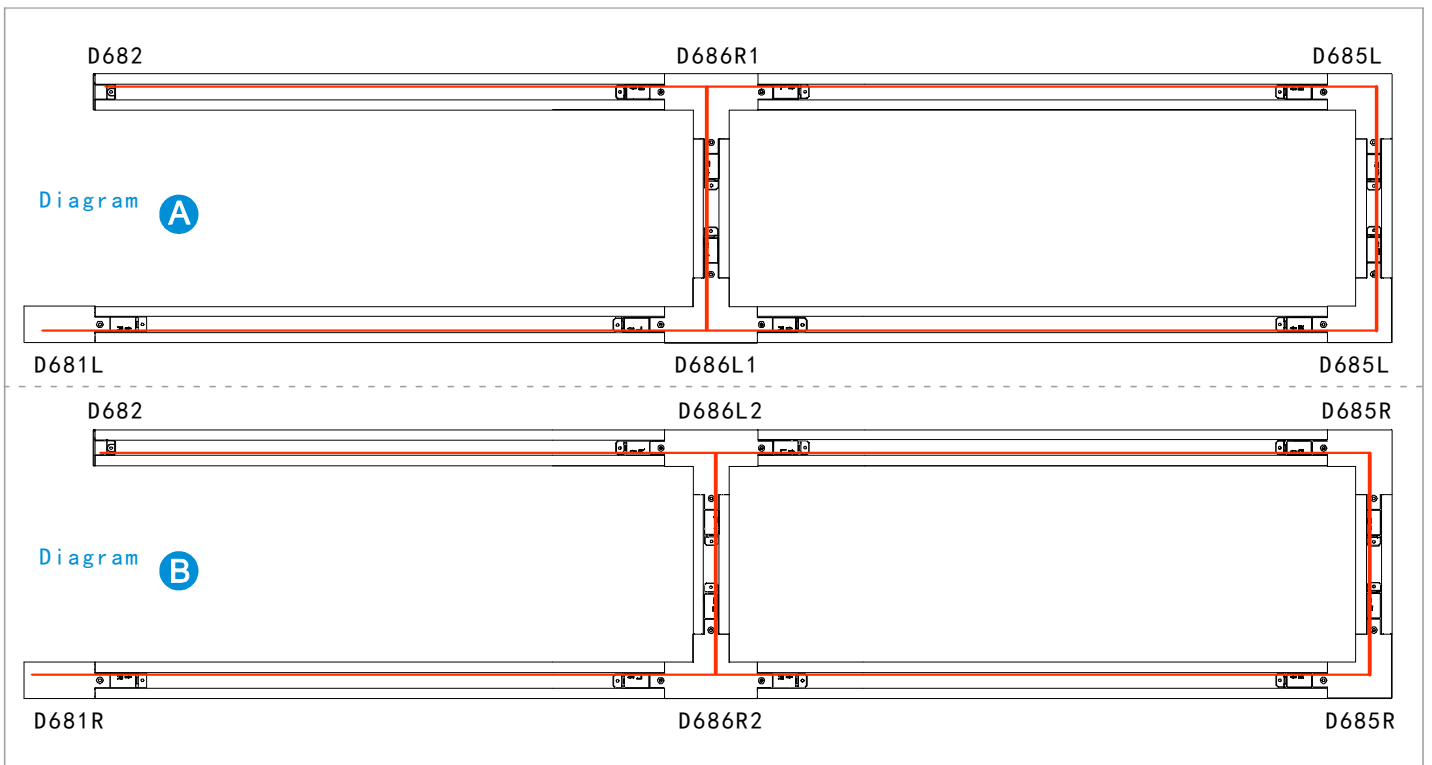

6 Wires 3 Circuits DALI Track System

6 Wires 3 Circuits DALI Track

Coextrusion Technology of Flat Copper Wire

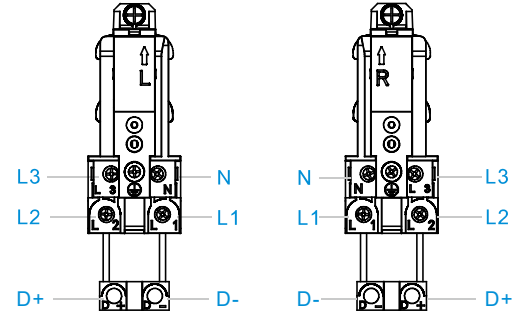
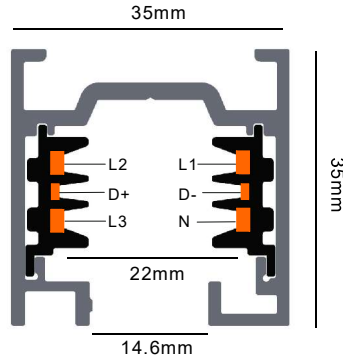
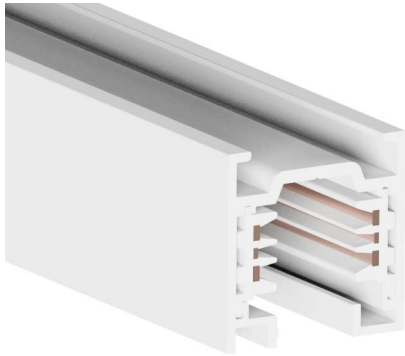

Model No.	Track Length	Colour	Package
D610-WH	1000mm	White	1 / 12
D610-BK	1000mm	Black	1 / 12
D610-SL	1000mm	Silver	1 / 12
D620-WH	2000mm	White	1 / 12
D620-BK	2000mm	Black	1 / 12
D620-SL	2000mm	Silver	1 / 12
D630-WH	3000mm	White	1 / 8
D630-BK	3000mm	Black	1 / 8
D630-SL	3000mm	Silver	1 / 8
D640-WH	4000mm	White	1 / 6
D640-BK	4000mm	Black	1 / 6
D640-SL	4000mm	Silver	1 / 6

Fixing Point Dimensions

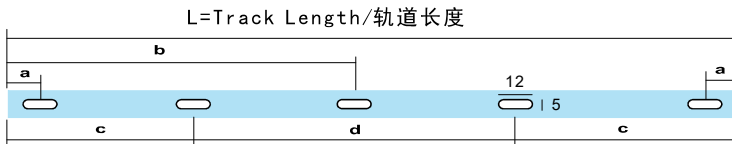

L/mm	a/mm	b/mm	c/mm	d/mm
1000	100			
2000	100	1000		
3000	100		1500	
4000	100		1333	1333

Mechanical Load Diagram

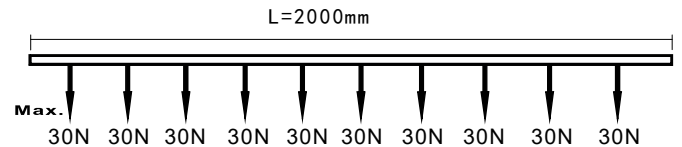
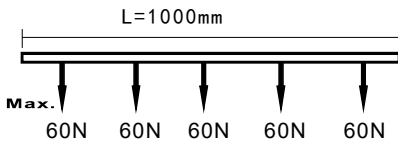

Connecting Diagram

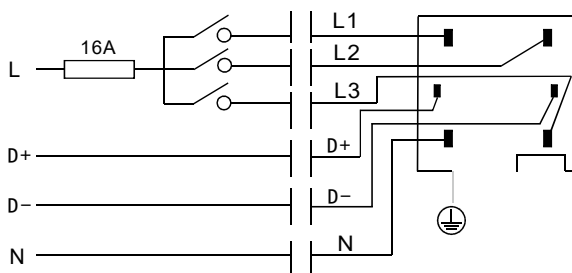

1 Phase 230VAC 16A Max + DALI

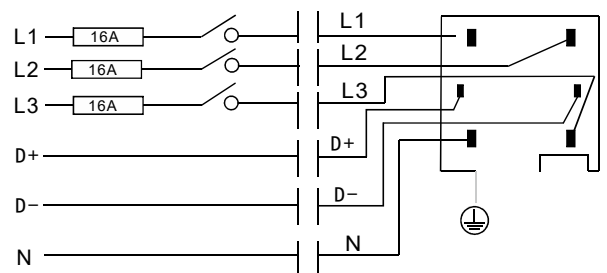

3 Phases 230VAC 3x16A Max + DALI

Track Power Connector (L)

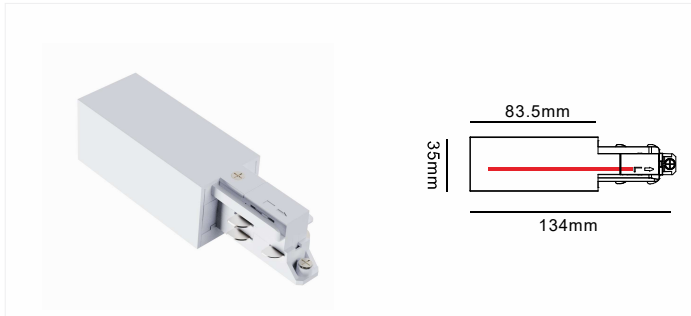

Model No.	Colour	Package
D681L-WH	White	1/150
D681L-BK	Black	1/150
D681L-SL	Silver	1/150

Track Power Connector (R)

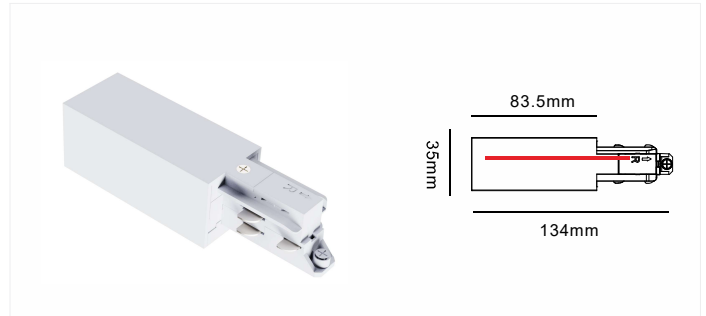

Model No.	Colour	Package
D681R-WH	White	1/150
D681R-BK	Black	1/150
D681R-SL	Silver	1/150

End Cap / 尾盖

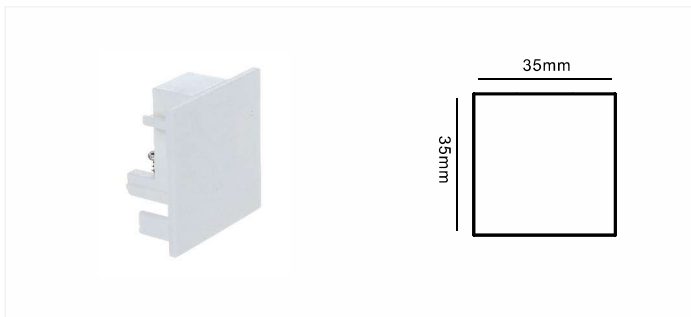

Model No.	Colour	Package
D682-WH	White	1/500
D682-BK	Black	1/500
D682-SL	Silver	1/500

Mini Joiner Connector / I形接驳器

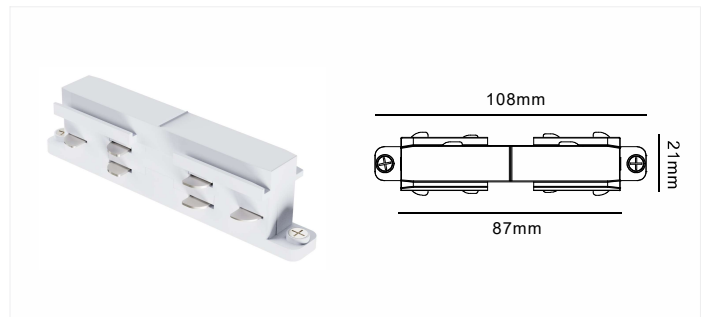

Model No.	Colour	Package
D683-WH	White	1/400
D683-BK	Black	1/400
D683-SL	Silver	1/400

Straight Connector

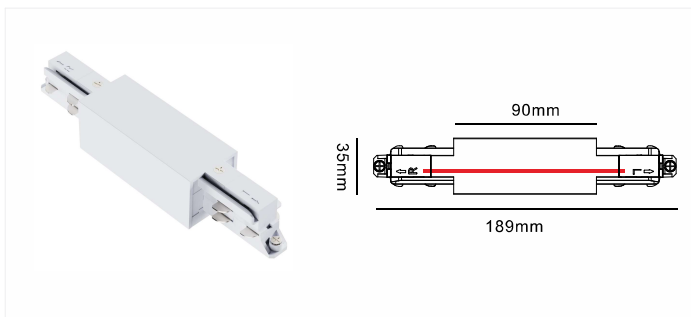

Model No.	Colour	Package
D684-WH	White	1/160
D684-BK	Black	1/160
D684-SL	Silver	1/160

“+” Cross Connector

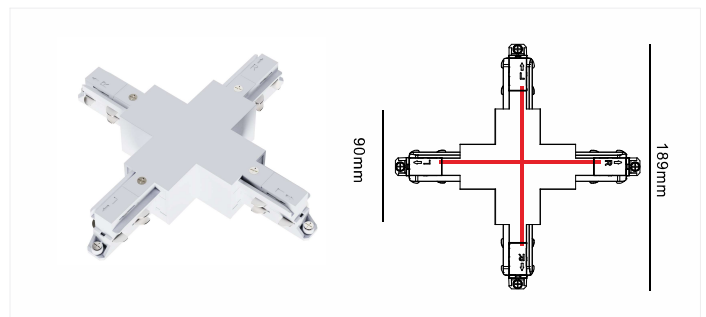

Model No.	Colour	Package
D687-WH	White	1/60
D687-BK	Black	1/60
D687-SL	Silver	1/60



“L” Connector (L)

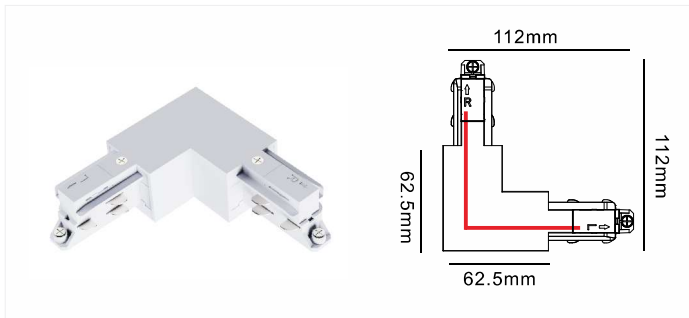

Model No.	Colour	Package
D685L-WH	White	1/150
D685L-BK	Black	1/150
D685L-SL	Silver	1/150

“L” Connector (R)

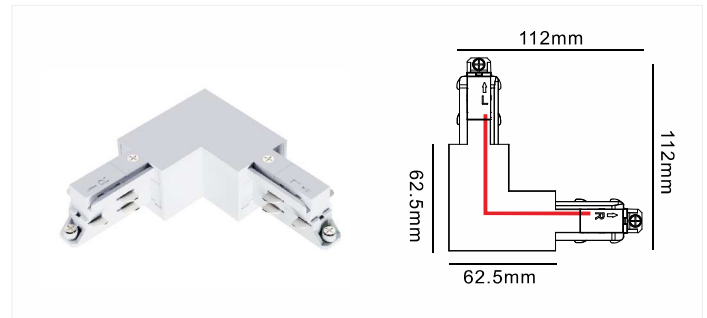

Model No.	Colour	Package
D685R-WH	White	1/150
D685R-BK	Black	1/150
D685R-SL	Silver	1/150

“T” Connector (L1)

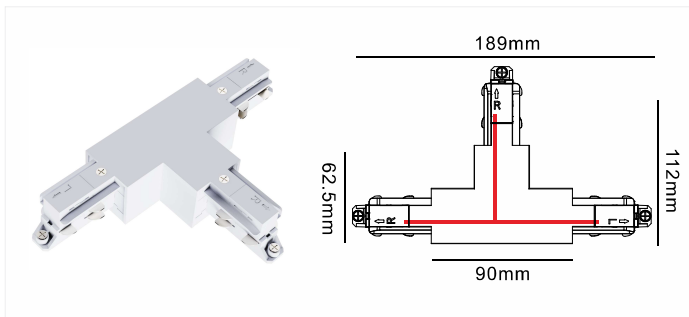

Model No.	Colour	Package
D686L1-WH	White	1/90
D686L1-BK	Black	1/90
D686L1-SL	Grey	1/90

“T” Connector (L2)

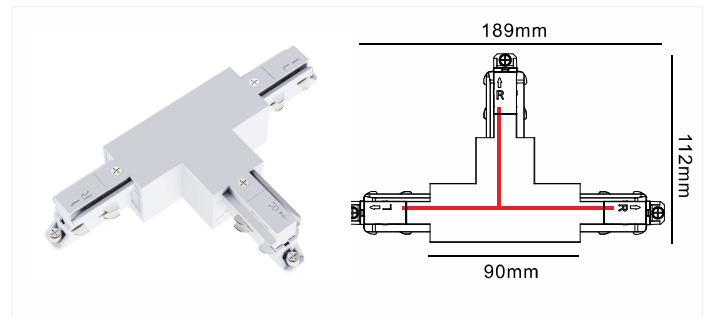

Model No.	Colour	Package
D686L2-WH	White	1/90
D686L2-BK	Black	1/90
D686L2-SL	Grey	1/90

“T” Connector (R1)

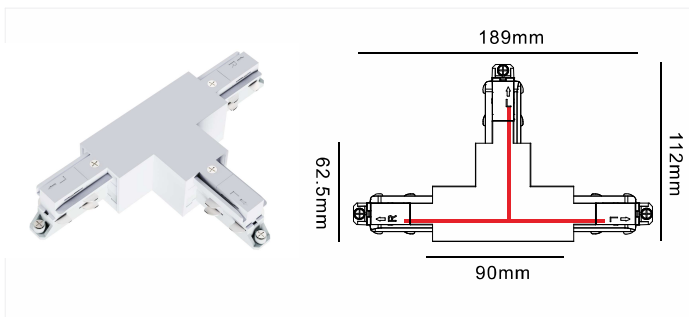

Model No.	Colour	Package
D686R1-WH	White	1/90
D686R1-BK	Black	1/90
D686R1-SL	Silver	1/90

“T” Connector (R2)

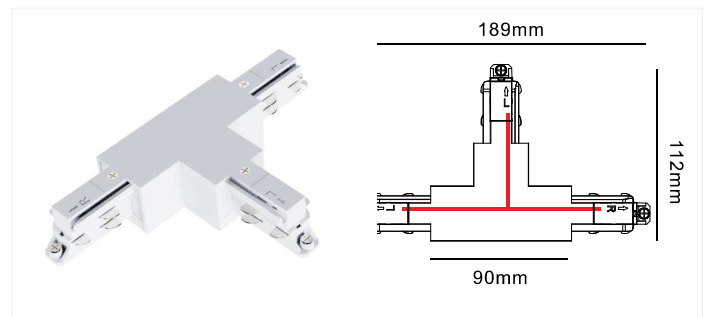

Model No.	Colour	Package
D686R2-WH	White	1/90
D686R2-BK	Black	1/90
D686R2-SL	Silver	1/90

6 Wires 3 Circuits DALI Track System

Twisted Connector

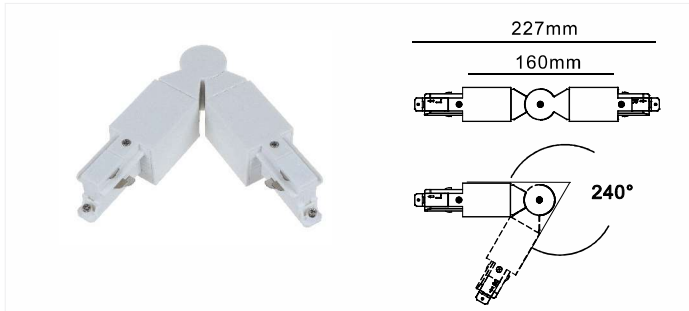

Model No.	Colour	Package
D688-WH	White	1/150
D688-BK	Black	1/150
D688-SL	Silver	1/150

Flexible Connector

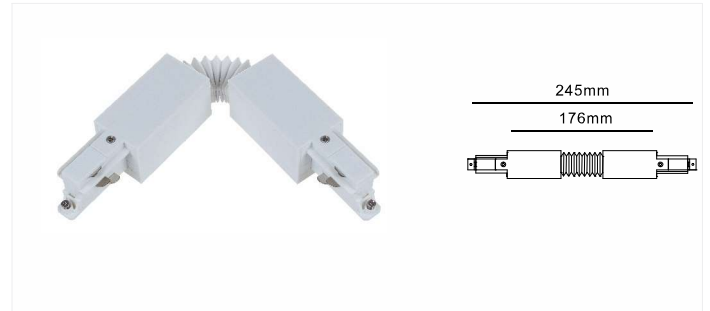

Model No.	Colour	Package
D689-WH	White	1/150
D689-BK	Black	1/150
D689-SL	Silver	1/150

Ceiling mount kit



Model No.	Colour	Package
D691-WH	White	1/200
D691-BK	Black	1/200
D691-SL	Silver	1/200

Connecting Plate

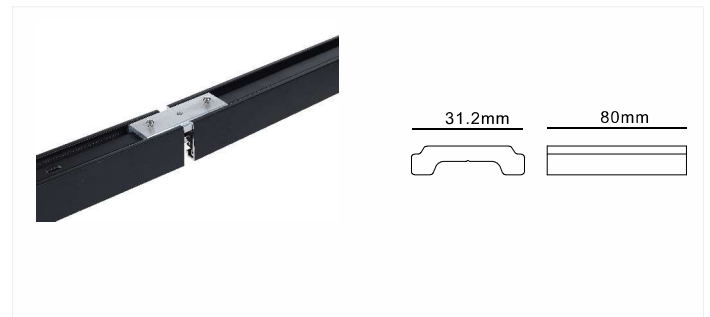

Model No.	Colour	Package
D692-WH	White	1/400
D692-BK	Black	1/400
D692-SL	Silver	1/400

Track Suspension Diagram

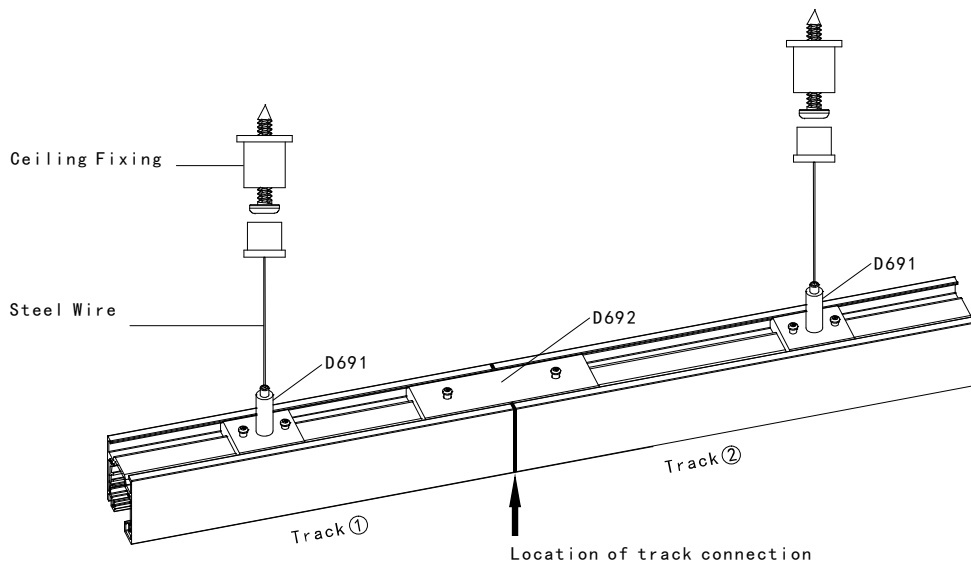

6 Wires 3 Circuits DALI Track System

6 Wires 3 Circuits Recessed Track (Deluxe)

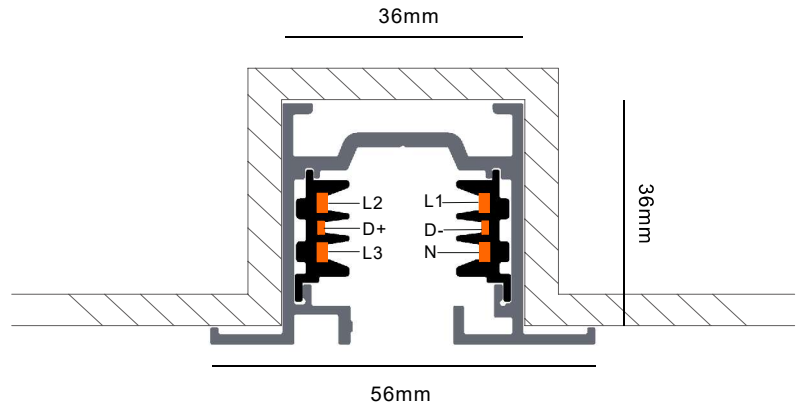
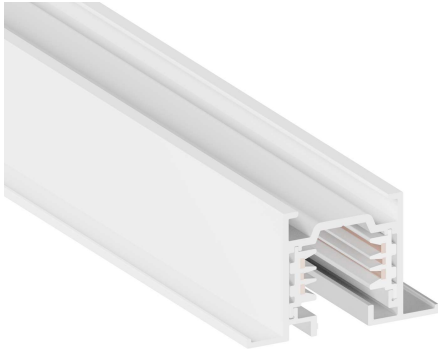

Model No.	Track Length	Colour	Package
RD610-WH	1000mm	White	1 / 12
RD610-BK	1000mm	Black	1 / 12
RD610-SL	1000mm	Silver	1 / 12
RD620-WH	2000mm	White	1 / 12
RD620-BK	2000mm	Black	1 / 12
RD620-SL	2000mm	Silver	1 / 12
RD630-WH	3000mm	White	1 / 8
RD630-BK	3000mm	Black	1 / 8
RD630-SL	3000mm	Silver	1 / 8
RD640-WH	4000mm	White	1 / 6
RD640-BK	4000mm	Black	1 / 6
RD640-SL	4000mm	Silver	1 / 6

Fixing Point Dimensions

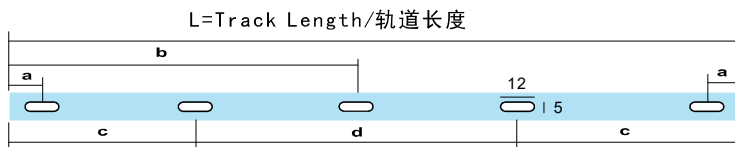

L/mm	a/mm	b/mm	c/mm	d/mm
1000	100			
2000	100	1000		
3000	100		1500	
4000	100		1333	1333

Mechanical Load Diagram

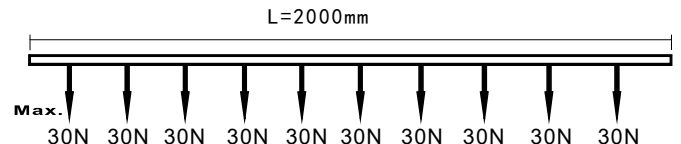
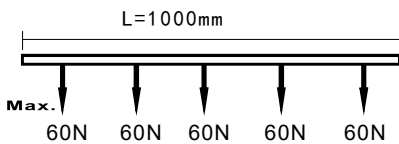

Connecting Diagram

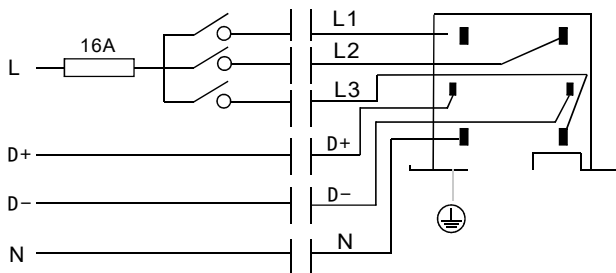

1 Phase 230VAC 16A Max + DALI

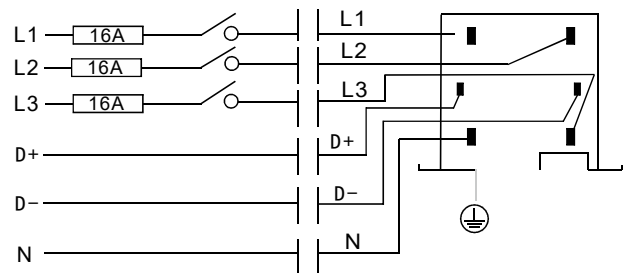

3 Phases 230VAC 3x16A Max + DALI

Power Connector Cover

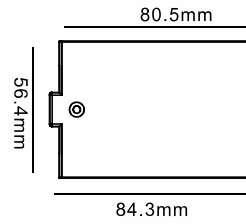

Model No.	Colour	Package
RD681-WH	White	1/500
RD681-BK	Black	1/500
RD681-SL	Silver	1/500

Straight Connector Cover

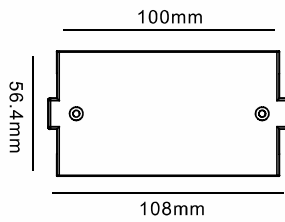

Model No.	Colour	Package
RD684-WH	White	1/500
RD684-BK	Black	1/500
RD684-SL	Silver	1/500

“L” Connector Cover

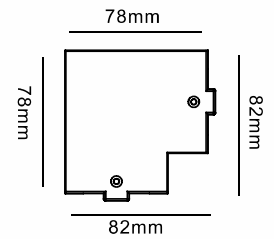

Model No.	Colour	Package
RD685-WH	White	1/500
RD685-BK	Black	1/500
RD685-SL	Silver	1/500

“T” Connector Cover

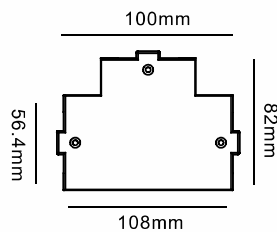

Model No.	Colour	Package
RD686-WH	White	1/500
RD686-BK	Black	1/500
RD686-SL	Silver	1/500

“+” Connector Cover

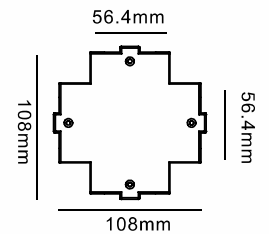

Model No.	Colour	Package
RD687-WH	White	1/500
RD687-BK	Black	1/500
RD687-SL	Silver	1/500

4 Wires Single Phase DALI Track System / 4线单回路DALI轨道系统

4 Wires DALI Track System Application 4线DALI轨道系统应用

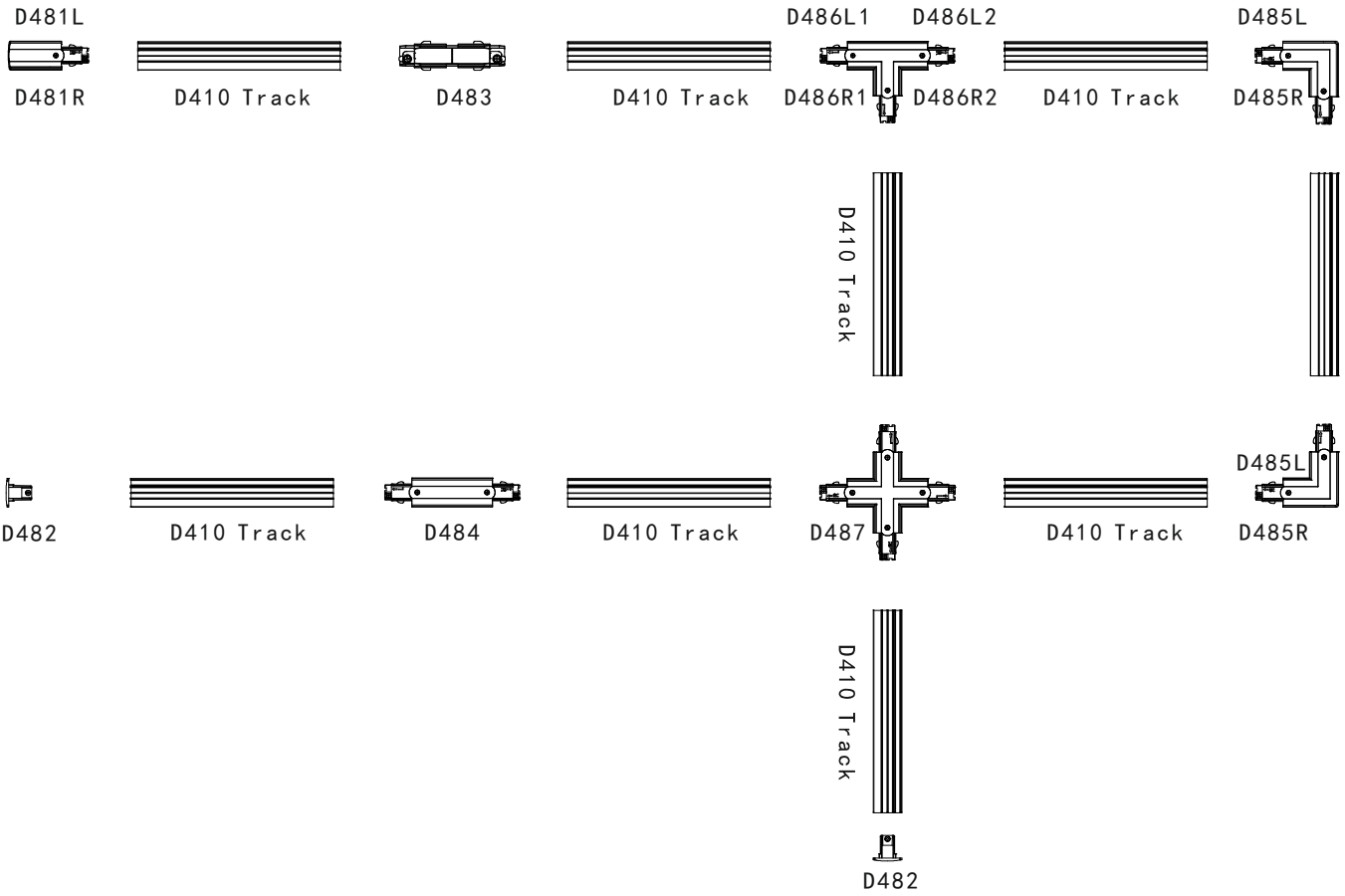

Connection Installation 安装说明

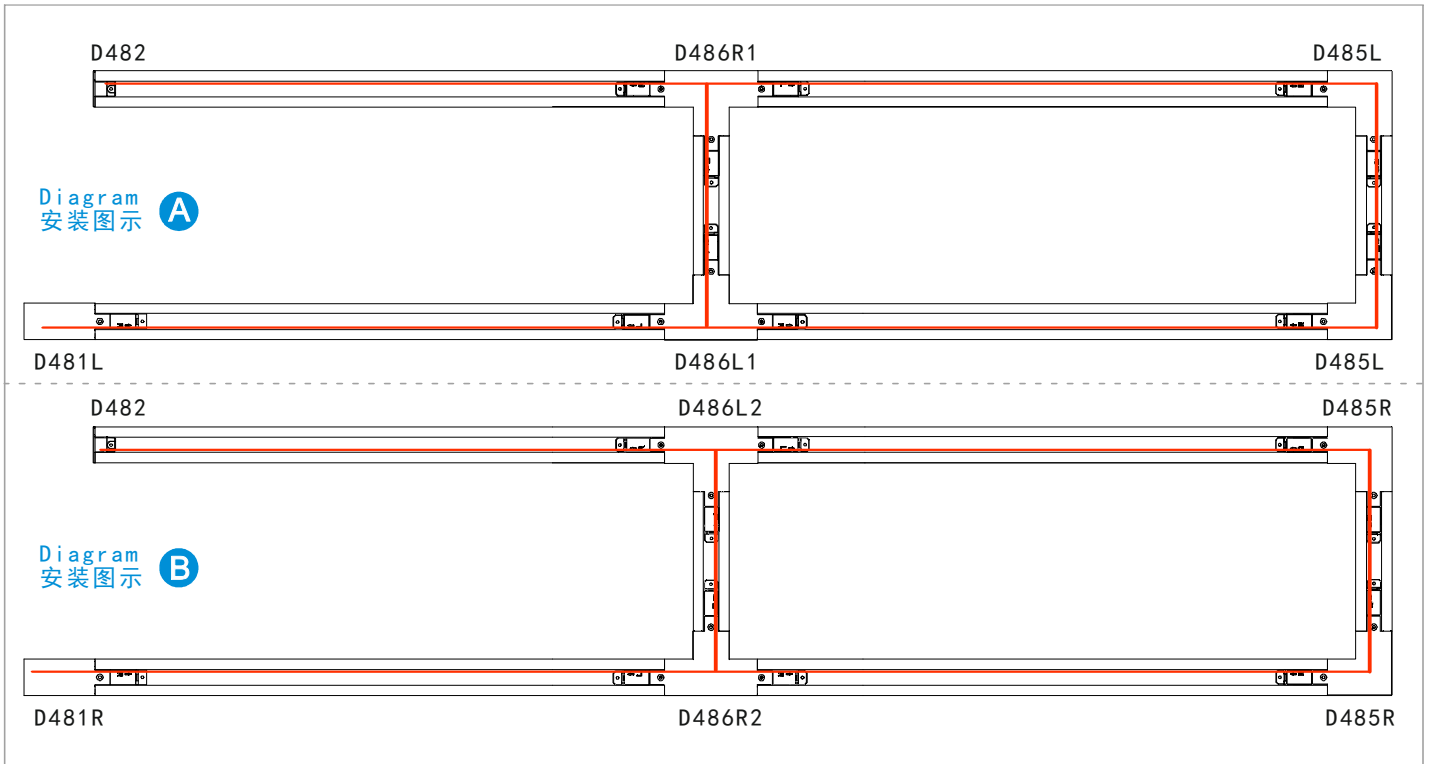

4 Wires Single Phase DALI Track System / 4线单回路DALI轨道系统

4 Wires Single Circuit DALI Track / 4线单回路DALI轨道



Coextrusion Technology of Flat Copper Wire
扁铜线共挤技术
导电弹片与轨道铜线有更多、更安全的接触面

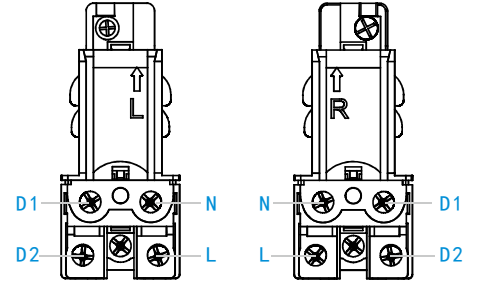
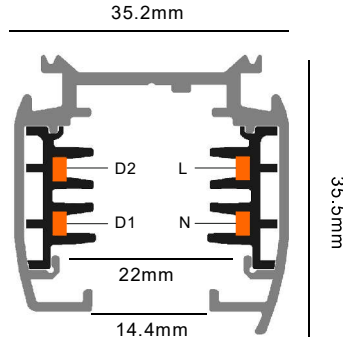

Model No. 产品型号	Track Length 轨道长度	Colour 产品颜色	Package 装箱数量
D410-WH	1000mm	White	1 / 12
D410-BK	1000mm	Black	1 / 12
D410-SL	1000mm	Silver	1 / 12
D420-WH	2000mm	White	1 / 12
D420-BK	2000mm	Black	1 / 12
D420-SL	2000mm	Silver	1 / 12
D430-WH	3000mm	White	1 / 8
D430-BK	3000mm	Black	1 / 8
D430-SL	3000mm	Silver	1 / 8
D440-WH	4000mm	White	1 / 6
D440-BK	4000mm	Black	1 / 6
D440-SL	4000mm	Silver	1 / 6

Fixing Point Dimensions / 轨道孔位尺寸

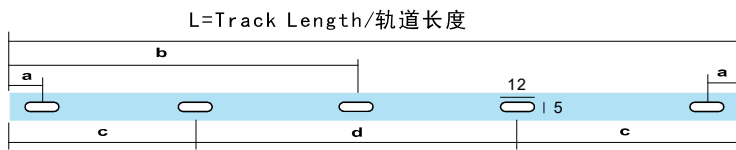

L/mm	a/mm	b/mm	c/mm	d/mm
1000	100			
2000	100	1000		
3000	100		1500	
4000	100		1333	1333

Mechanical Load Diagram / 轨道承重图

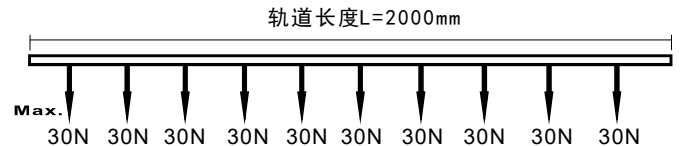
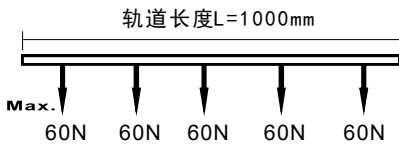

Connecting Diagram / 轨道接线图

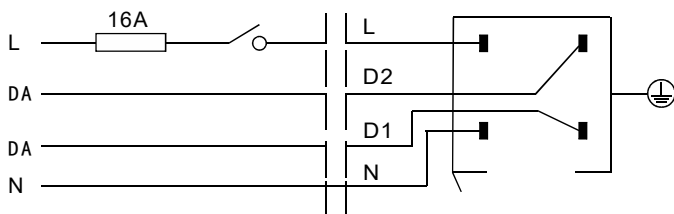

1 Phases / 单相电230VAC 16A Max+ DALI信号线

Track Power Connector (L) / 轨道电源头 (左)

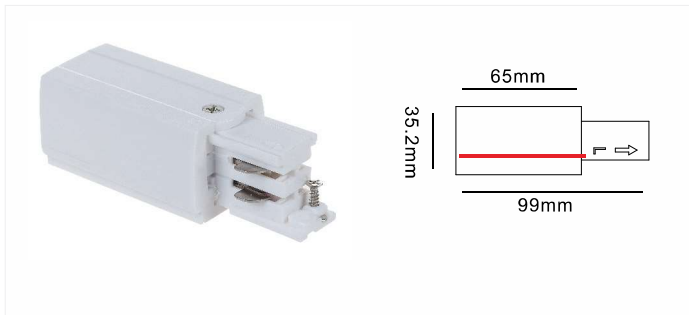

Model No. 产品型号	Colour 产品颜色	Package 装箱数量
D481L-WH	White	1/150
D481L-BK	Black	1/150
D481L-SL	Silver	1/150

Track Power Connector (R) / 轨道电源头 (右)

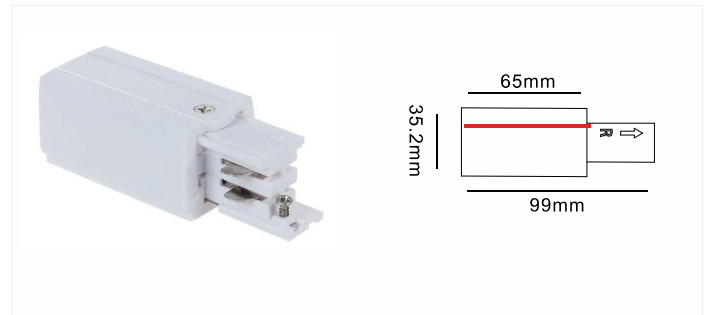

Model No. 产品型号	Colour 产品颜色	Package 装箱数量
D481R-WH	White	1/150
D481R-BK	Black	1/150
D481R-SL	Silver	1/150

End Cap / 尾盖

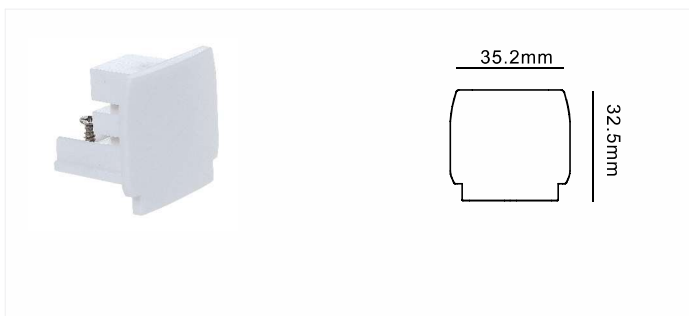

Model No. 产品型号	Colour 产品颜色	Package 装箱数量
D482-WH	White	1/500
D482-BK	Black	1/500
D482-SL	Silver	1/500

Mini Joiner Connector / I形接驳器

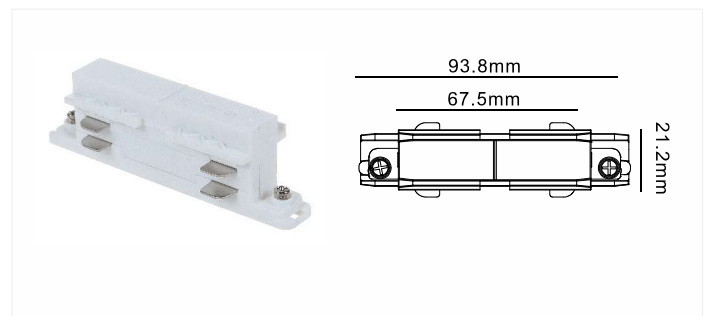

Model No. 产品型号	Colour 产品颜色	Package 装箱数量
D483-WH	White	1/400
D483-BK	Black	1/400
D483-SL	Silver	1/400

Straight Connector / 直线接驳器

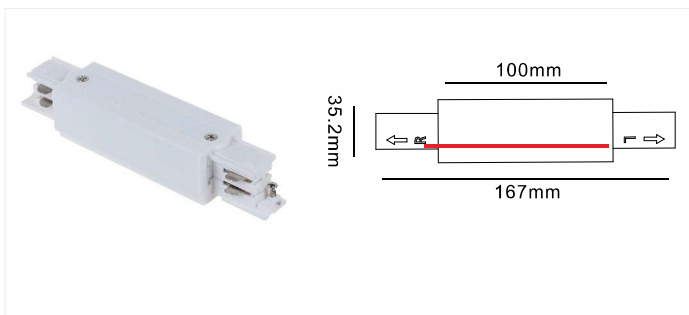

Model No. 产品型号	Colour 产品颜色	Package 装箱数量
D484-WH	White	1/160
D484-BK	Black	1/160
D484-SL	Silver	1/160

“十” Cross Connector / 十字接驳器

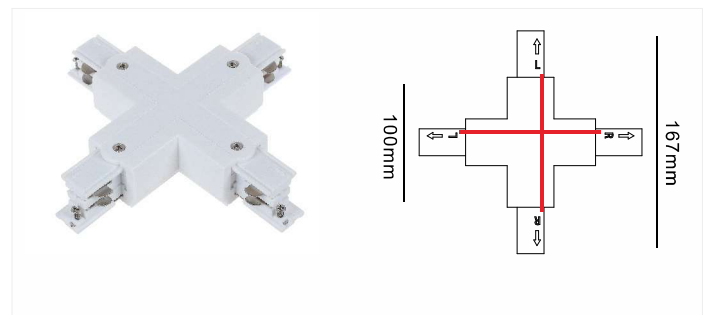

Model No. 产品型号	Colour 产品颜色	Package 装箱数量
D487-WH	White	1/60
D487-BK	Black	1/60
D487-SL	Silver	1/60



“L” Connector (L) / L形接驳器 (左)

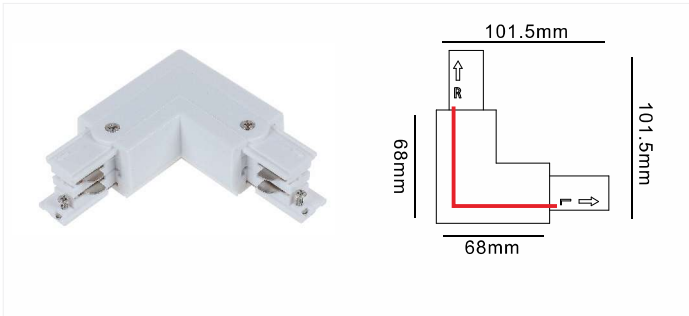

Model No. 产品型号	Colour 产品颜色	Package 装箱数量
D485L-WH	White	1/150
D485L-BK	Black	1/150
D485L-SL	Silver	1/150

“L” Connector (R) / L形接驳器 (右)

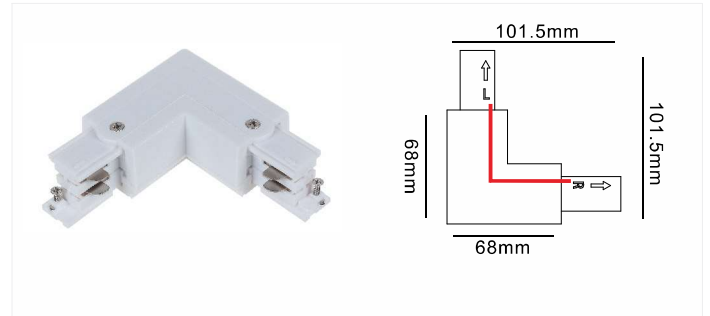

Model No. 产品型号	Colour 产品颜色	Package 装箱数量
D485R-WH	White	1/150
D485R-BK	Black	1/150
D485R-SL	Silver	1/150

“T” Connector (L1) / T形接驳器 (左1)

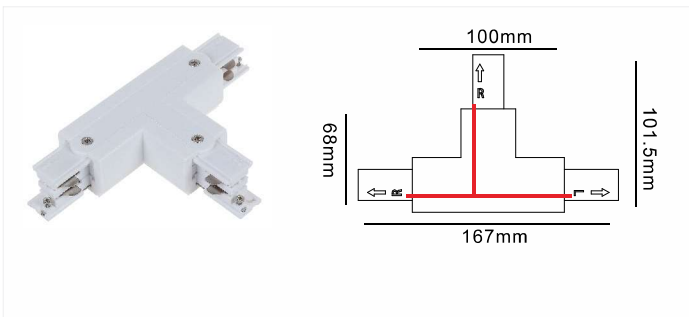

Model No. 产品型号	Colour 产品颜色	Package 装箱数量
D486L1-WH	White	1/90
D486L1-BK	Black	1/90
D486L1-SL	Silver	1/90

“T” Connector (L2) / T形接驳器 (左2)

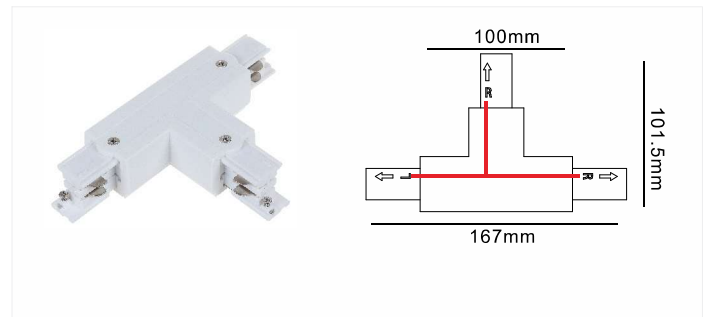

Model No. 产品型号	Colour 产品颜色	Package 装箱数量
D486L2-WH	White	1/90
D486L2-BK	Black	1/90
D486L2-SL	Silver	1/90

“T” Connector (R1) / T形接驳器 (右1)

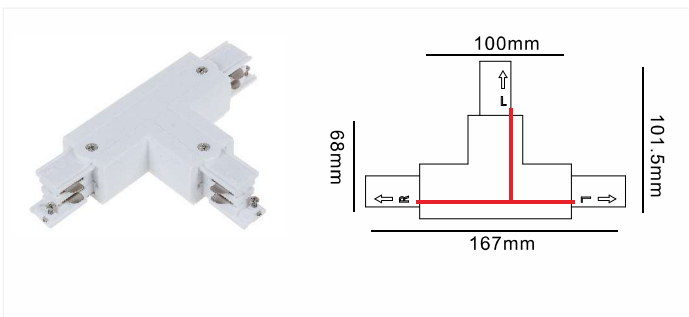

Model No. 产品型号	Colour 产品颜色	Package 装箱数量
D486R1-WH	White	1/90
D486R1-BK	Black	1/90
D486R1-SL	Silver	1/90

“T” Connector (R2) / T形接驳器 (右2)

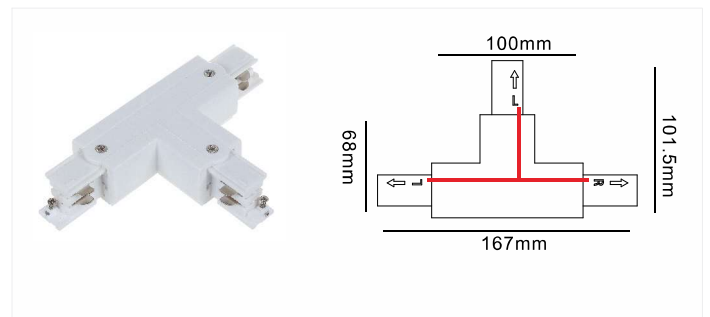

Model No. 产品型号	Colour 产品颜色	Package 装箱数量
D486R2-WH	White	1/90
D486R2-BK	Black	1/90
D486R2-SL	Silver	1/90

4 Wires Single Phase DALI Track System / 4线单回路DALI轨道系统

4 Wires DALI adaptor / 4线DALI轨道头

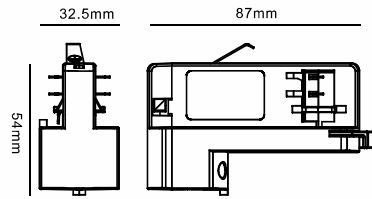

Model No.
产品型号

D403-WH
D403-BK
D403-SL

Colour
产品颜色

White
Black
Silver

Package
装箱数量

1/200
1/200
1/200

4 Wires Single Circuit DALI Gearbox (Big)

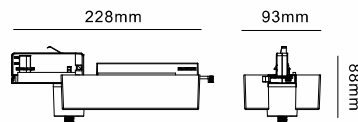

Inside Size: L127*W86*H38mm

Model No.
产品型号

D451-WH
D451-BK
D451-SL

Colour
产品颜色

White
Black
Silver

Package
装箱数量

1/60
1/60
1/60

4 Wires Single Circuit DALI Gearbox (Small)

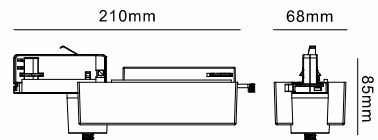

Inside Size: L109*W60*H36mm

Model No.
产品型号

D452-WH
D452-BK
D452-SL

Colour
产品颜色

White
Black
Silver

Package
装箱数量

1/80
1/80
1/80

4 Wires 3 Circuits Track System(Regular) / 4线三回路轨道系统 (常规款)

4 Wires Track System Application 4线轨道系统应用

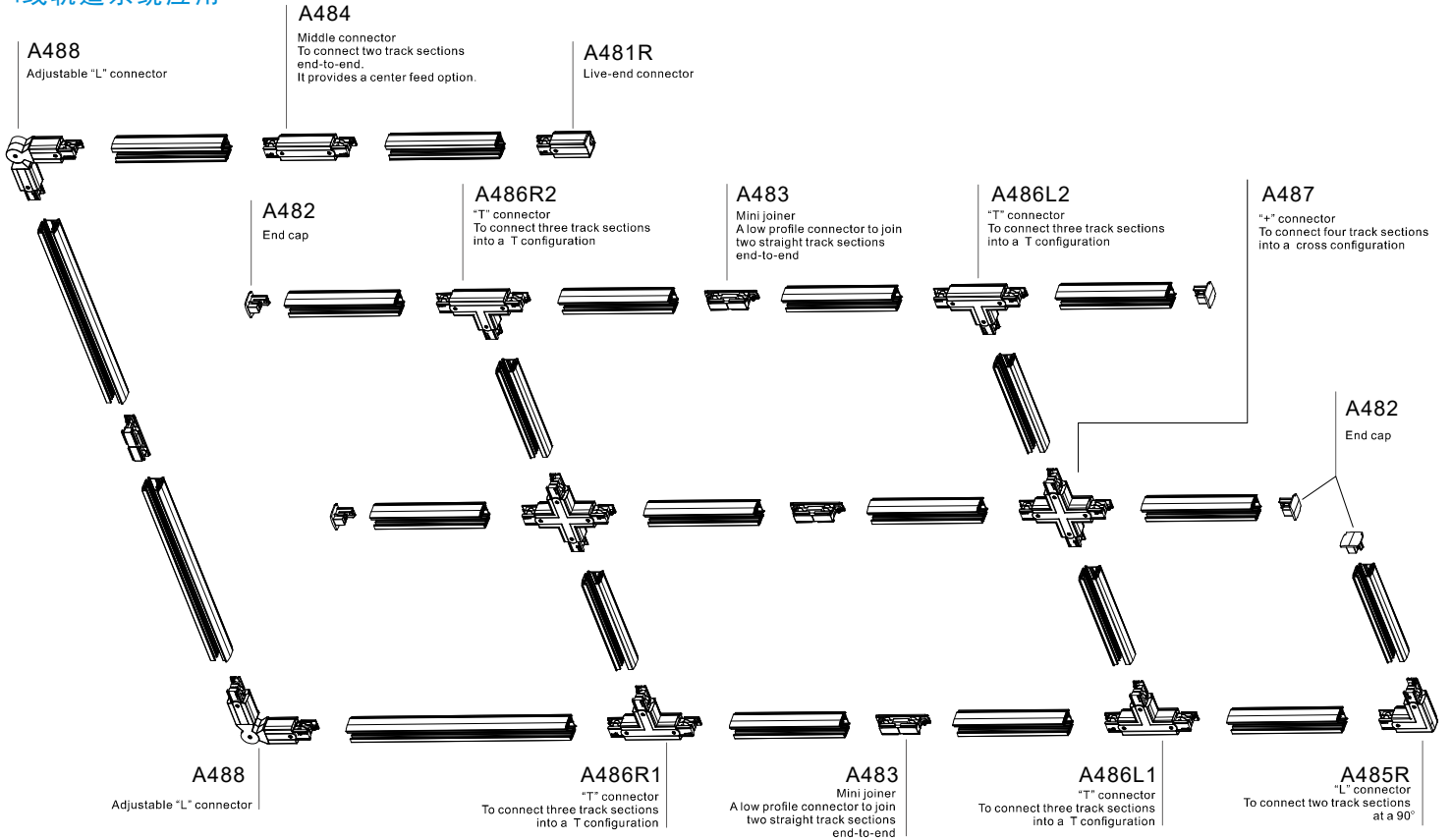

Connection Installation 安装说明

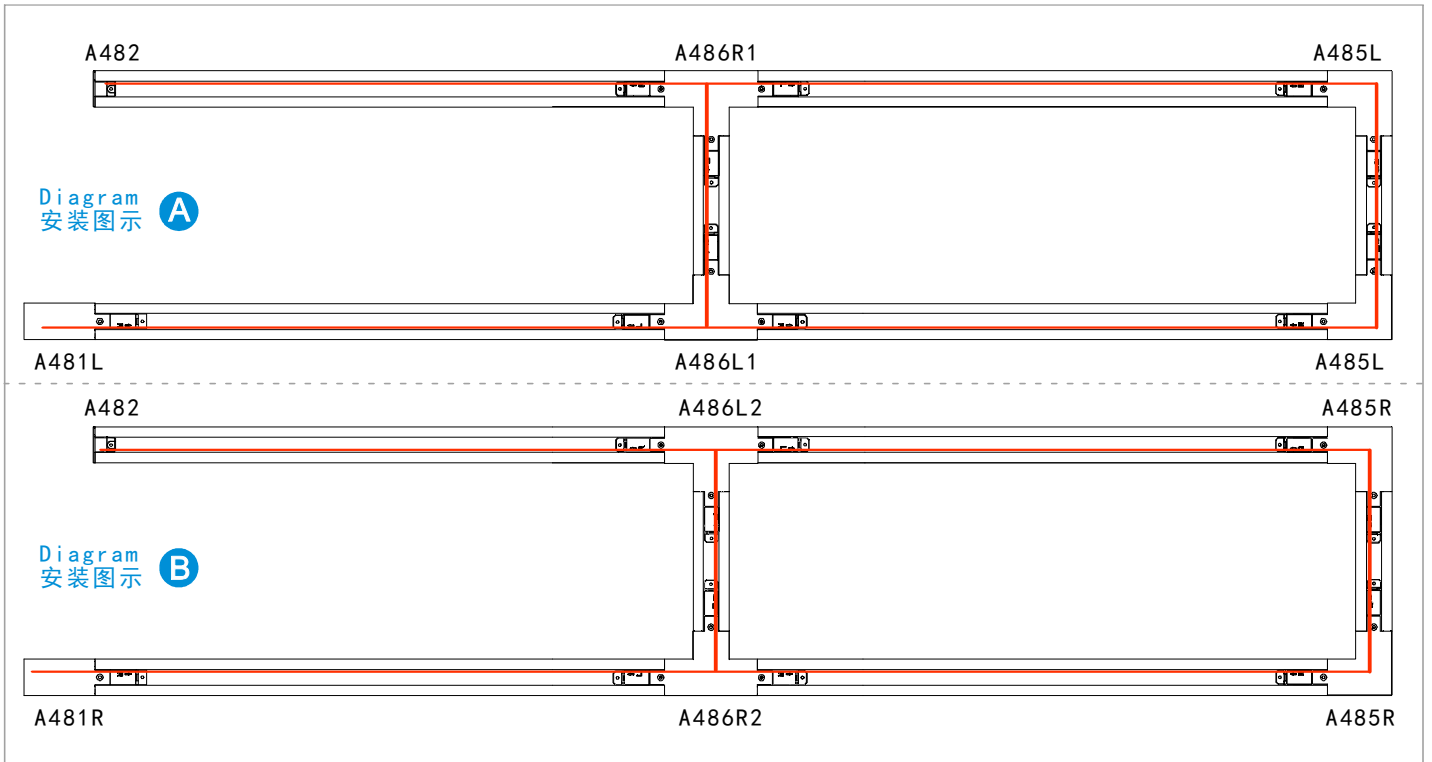

4 Wires 3 Circuits Track System(Regular) / 4线三回路轨道系统 (常规款)

4 Wires Track System / 4线轨道系统安装效果图

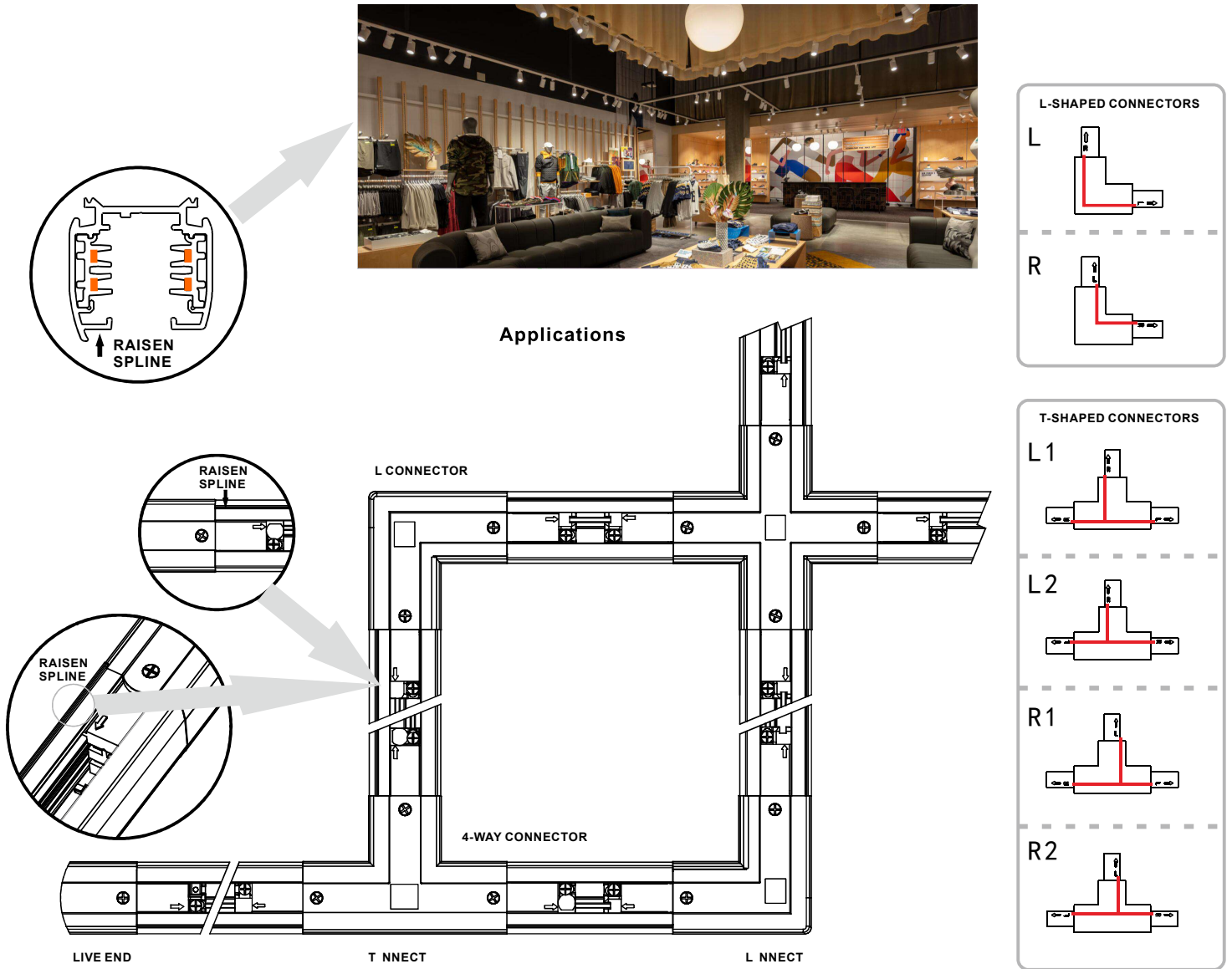

Connecting Diagram / 轨道接线图

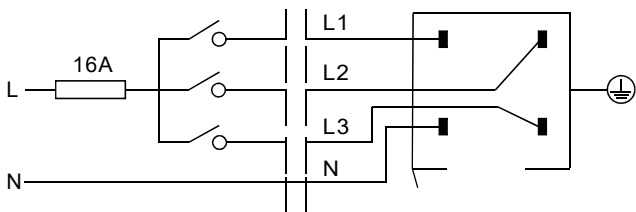

1 Phase / 单相电 230VAC 16A Max

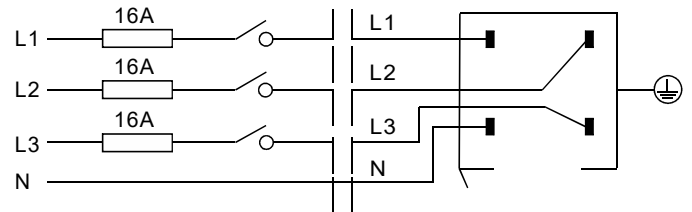

3 Phases / 三相电 230VAC 3x16A Max

4 Wires 3 Circuits Track System(Regular) / 4线三回路轨道系统 (常规款)

4 Wires 3 Circuits Track (Regular) / 4线3回路轨道 (常规款)



Coextrusion Technology of Flat Copper Wire
扁铜线共挤技术
导电弹片与轨道铜线有更多、更安全的接触面

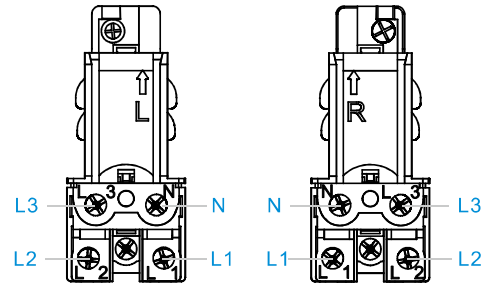
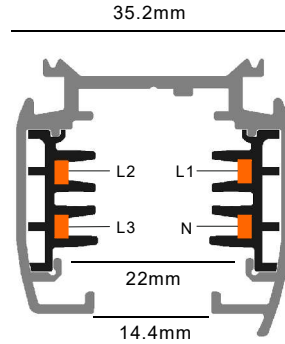

Model No. 产品型号	Track Length 轨道长度	Colour 产品颜色	Package 装箱数量
A410-WH	1000mm	White	1 / 12
A410-BK	1000mm	Black	1 / 12
A410-SL	1000mm	Silver	1 / 12
A420-WH	2000mm	White	1 / 12
A420-BK	2000mm	Black	1 / 12
A420-SL	2000mm	Silver	1 / 12
A430-WH	3000mm	White	1 / 8
A430-BK	3000mm	Black	1 / 8
A430-SL	3000mm	Silver	1 / 8
A440-WH	4000mm	White	1 / 6
A440-BK	4000mm	Black	1 / 6
A440-SL	4000mm	Silver	1 / 6

Fixing Point Dimensions / 轨道孔位尺寸

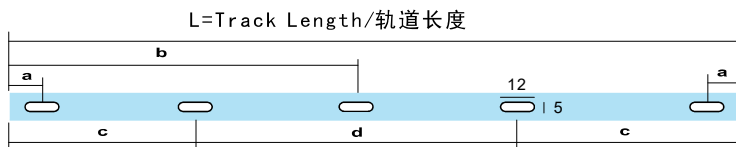

L/mm	a/mm	b/mm	c/mm	d/mm
1000	100			
2000	100	1000		
3000	100		1500	
4000	100		1333	1333

Mechanical Load Diagram / 轨道承重图

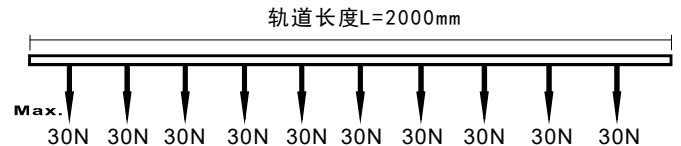
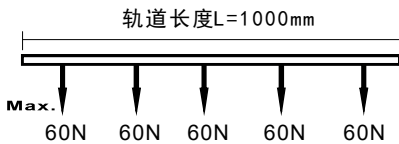

Connecting Diagram / 轨道接线图

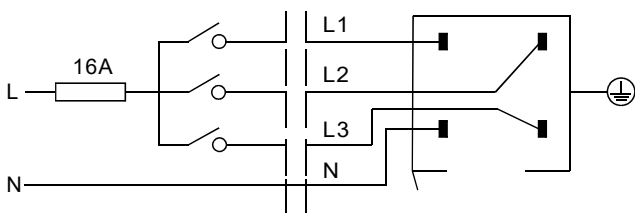

1 Phase / 单相电 230VAC 16A Max

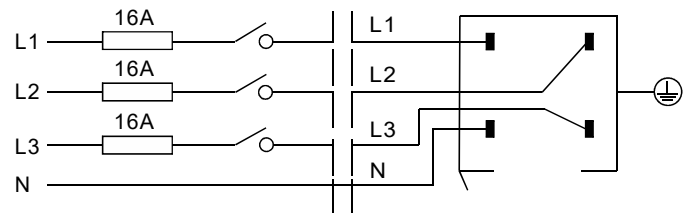

3 Phases / 三相电 230VAC 3x16A Max

4 Wires 3 Circuits Track System(Regular) / 4线三回路轨道系统（常规款）

Track Power Connector (L) / 轨道电源头（左）

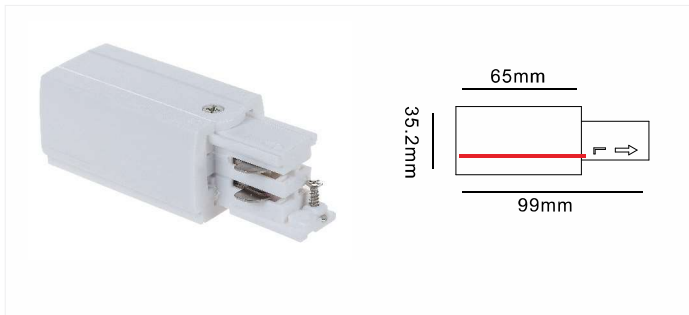

Model No. 产品型号	Colour 产品颜色	Package 装箱数量
A481L-WH	White	1/150
A481L-BK	Black	1/150
A481L-SL	Silver	1/150

Track Power Connector (R) / 轨道电源头（右）

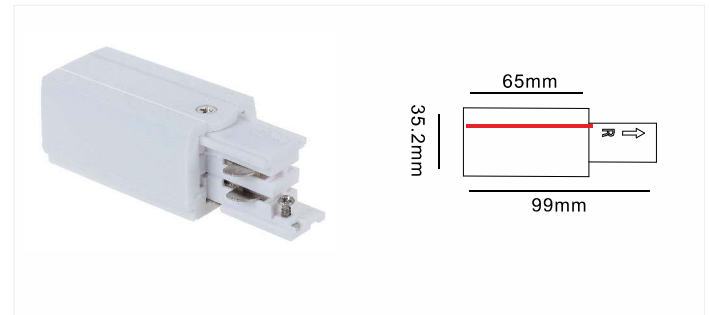

Model No. 产品型号	Colour 产品颜色	Package 装箱数量
A481R-WH	White	1/150
A481R-BK	Black	1/150
A481R-SL	Silver	1/150

End Cap / 尾盖

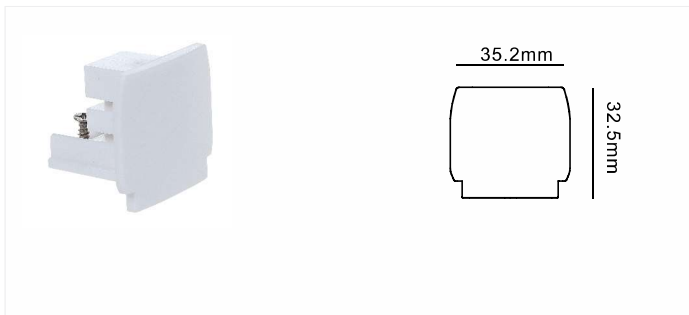

Model No. 产品型号	Colour 产品颜色	Package 装箱数量
A482-WH	White	1/500
A482-BK	Black	1/500
A482-SL	Silver	1/500

Mini Joiner Connector / I形接驳器

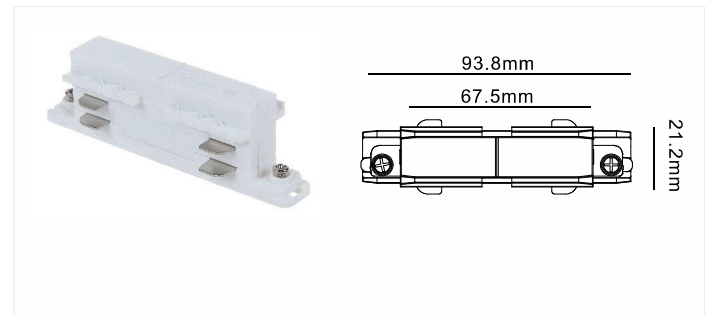

Model No. 产品型号	Colour 产品颜色	Package 装箱数量
A483-WH	White	1/400
A483-BK	Black	1/400
A483-SL	Silver	1/400

Straight Connector / 直线接驳器

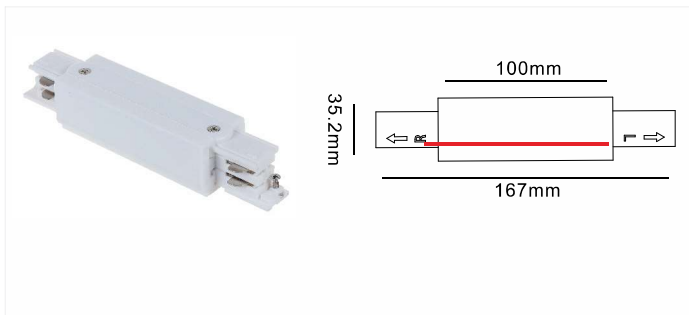

Model No. 产品型号	Colour 产品颜色	Package 装箱数量
A484-WH	White	1/160
A484-BK	Black	1/160
A484-SL	Silver	1/160

“十” Cross Connector / 十字接驳器

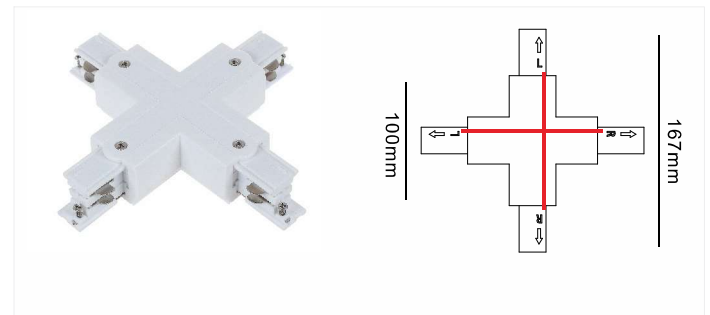

Model No. 产品型号	Colour 产品颜色	Package 装箱数量
A487-WH	White	1/60
A487-BK	Black	1/60
A487-SL	Silver	1/60

4 Wires 3 Circuits Track System(Regular) / 4线三回路轨道系统（常规款）

“L” Connector (L) / L形接驳器（左）

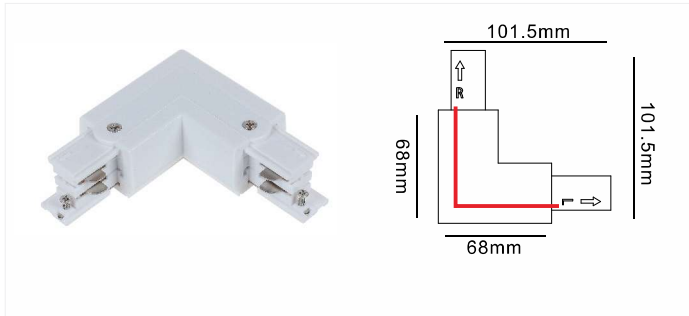

Model No. 产品型号	Colour 产品颜色	Package 装箱数量
A485L-WH	White	1/150
A485L-BK	Black	1/150
A485L-SL	Silver	1/150

“L” Connector (R) / L形接驳器（右）

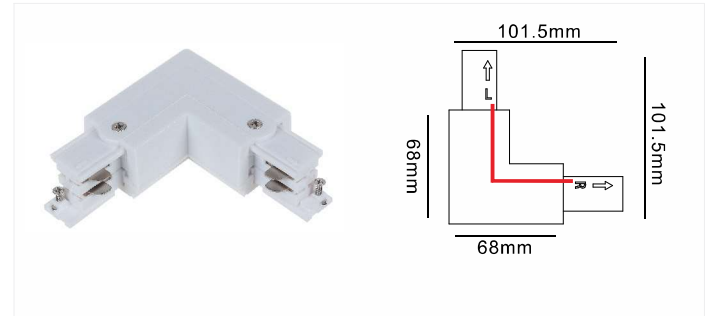

Model No. 产品型号	Colour 产品颜色	Package 装箱数量
A485R-WH	White	1/150
A485R-BK	Black	1/150
A485R-SL	Silver	1/150

“T” Connector (L1) / T形接驳器（左1）

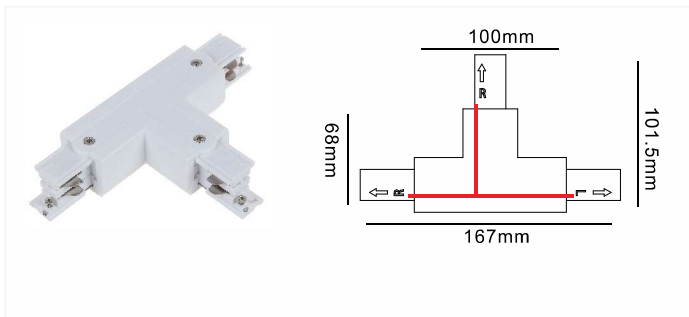

Model No. 产品型号	Colour 产品颜色	Package 装箱数量
A486L1-WH	White	1/90
A486L1-BK	Black	1/90
A486L1-SL	Silver	1/90

“T” Connector (L2) / T形接驳器（左2）

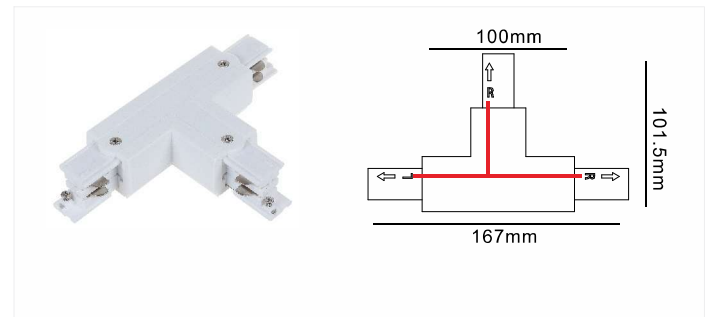

Model No. 产品型号	Colour 产品颜色	Package 装箱数量
A486L2-WH	White	1/90
A486L2-BK	Black	1/90
A486L2-SL	Silver	1/90

“T” Connector (R1) / T形接驳器（右1）

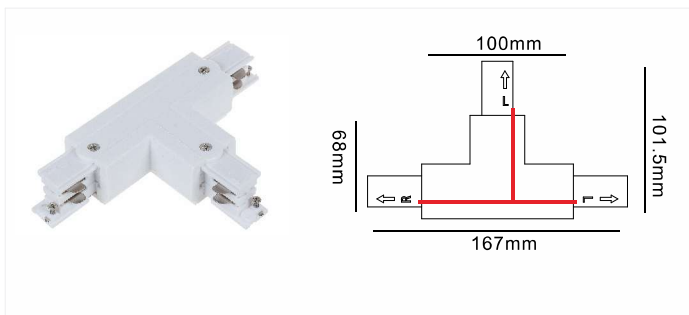

Model No. 产品型号	Colour 产品颜色	Package 装箱数量
A486R1-WH	White	1/90
A486R1-BK	Black	1/90
A486R1-SL	Silver	1/90

“T” Connector (R2) / T形接驳器（右2）

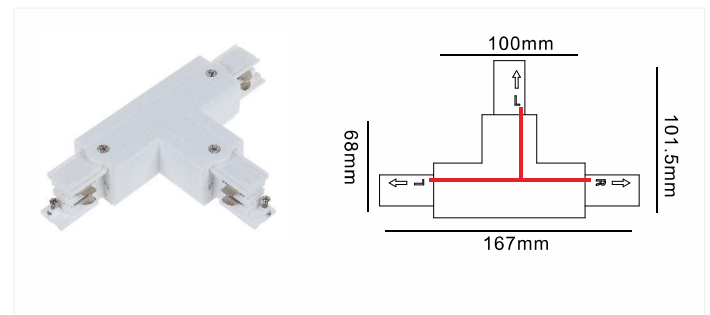

Model No. 产品型号	Colour 产品颜色	Package 装箱数量
A486R2-WH	White	1/90
A486R2-BK	Black	1/90
A486R2-SL	Silver	1/90

4 Wires 3 Circuits Track System(Regular) / 4线三回路轨道系统（常规款）

Twisted Connector / 万向型接驳器

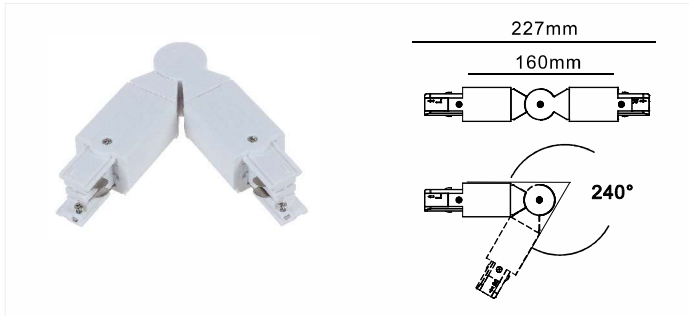

Model No. 产品型号	Colour 产品颜色	Package 装箱数量
A488-WH	White	1/90
A488-BK	Black	1/90
A488-SL	Silver	1/90

Flexible Connector / 软管接驳器



Model No. 产品型号	Colour 产品颜色	Package 装箱数量
A489-WH	White	1/90
A489-BK	Black	1/90
A489-SL	Silver	1/90

4 Wires Track Ceiling Box / 4线圆盘轨道吸顶盒

Track Ceiling Box / 圆盘轨道吸顶盒

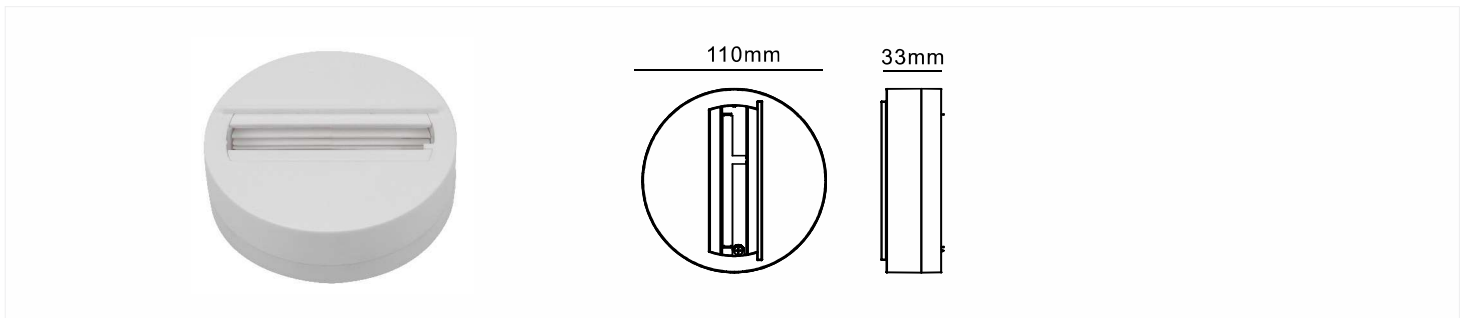

Model No. 产品型号	Colour 产品颜色	Package 装箱数量
C400-WH	White	1/100
C400-BK	Black	1/100
C400-SL	Silver	1/100

Connection Installation 安装说明



Connecting Diagram 接线图

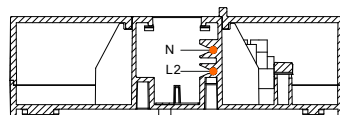

4 Wires 3 Circuits Track System(Regular) / 4线三回路轨道系统（常规款）

Celling mount kit / 悬挂吊件组

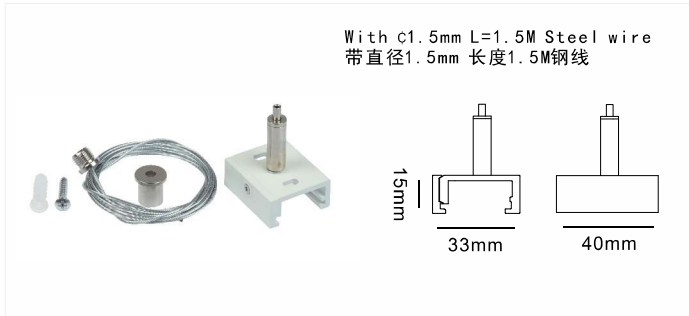

Model No. 产品型号	Colour 产品颜色	Package 装箱数量
A491-WH	White	1/200
A491-BK	Black	1/200
A491-SL	Silver	1/200

Suspension Mount EZCLK Kit / 悬吊易力夹组件



Model No. 产品型号	Colour 产品颜色	Package 装箱数量
A492-WH	White	1/200
A492-BK	Black	1/200
A492-SL	Silver	1/200

Suspension Kit / 吸顶组件

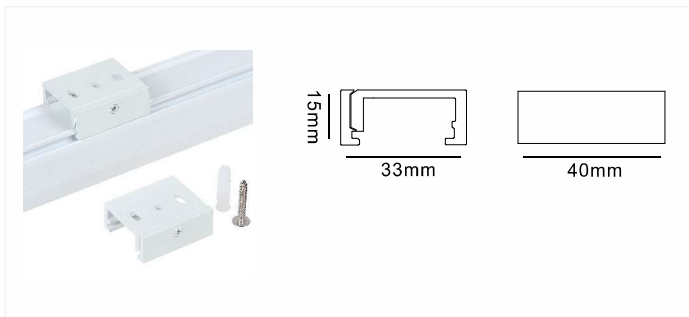

Model No. 产品型号	Colour 产品颜色	Package 装箱数量
A493-WH	White	1/1000
A493-BK	Black	1/1000
A493-SL	Silver	1/1000

Suspension Clamp / 轨道连接吊夹

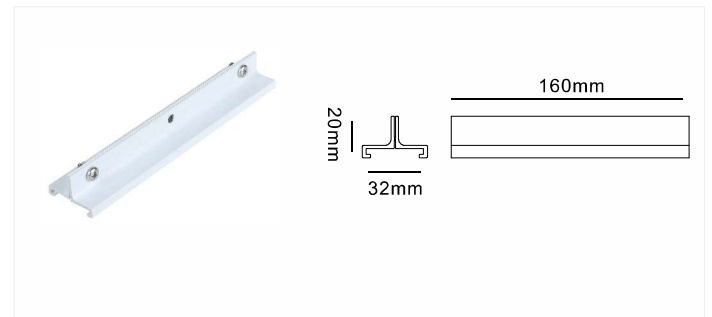

Model No. 产品型号	Colour 产品颜色	Package 装箱数量
A494-WH	White	1/500
A494-BK	Black	1/500
A494-SL	Silver	1/500

Track Suspension Diagram 轨道吊件安装图

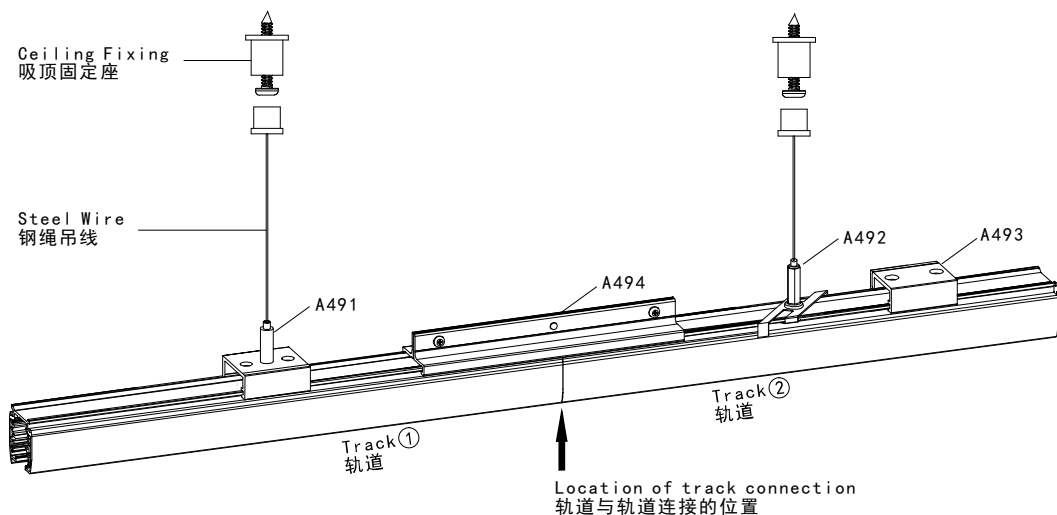

4 Wires 3 Circuits Track System(Regular) / 4线三回路轨道系统（常规款）

4 Wires 3 Circuits Recessed Track(Regular) / 4线3回路嵌入式轨道（常规款）

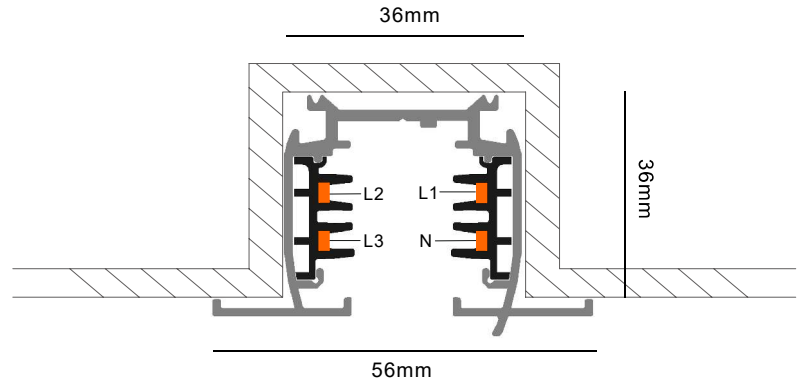

Model No. 产品型号	Track Length 轨道长度	Colour 产品颜色	Package 装箱数量
RA410-WH	1000mm	White	1 / 12
RA410-BK	1000mm	Black	1 / 12
RA410-SL	1000mm	Silver	1 / 12
RA420-WH	2000mm	White	1 / 12
RA420-BK	2000mm	Black	1 / 12
RA420-SL	2000mm	Silver	1 / 12
RA430-WH	3000mm	White	1 / 8
RA430-BK	3000mm	Black	1 / 8
RA430-SL	3000mm	Silver	1 / 8
RA440-WH	4000mm	White	1 / 6
RA440-BK	4000mm	Black	1 / 6
RA440-SL	4000mm	Silver	1 / 6

Fixing Point Dimensions / 轨道孔位尺寸

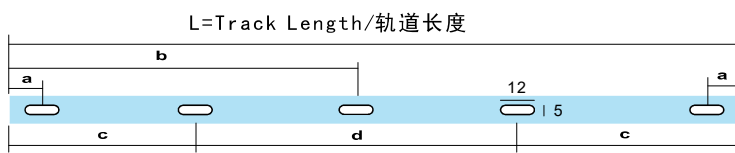

L/mm	a/mm	b/mm	c/mm	d/mm
1000	100			
2000	100	1000		
3000	100		1500	
4000	100		1333	1333

Mechanical Load Diagram / 轨道承重图

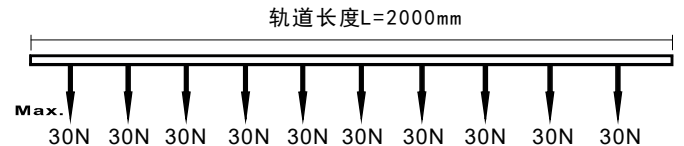
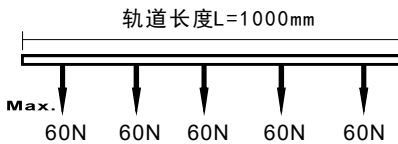

Connecting Diagram / 轨道接线图

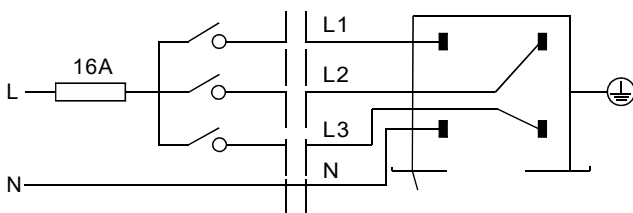

1 Phase / 单相电 230VAC 16A Max

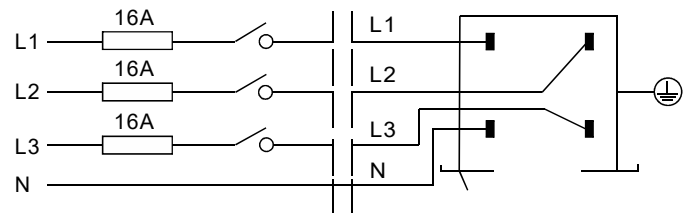

3 Phases / 三相电 230VAC 3x16A Max

4 Wires 3 Circuits Track System(Regular) / 4线三回路轨道系统（常规款）

Power Connector Cover / 电源头盖板

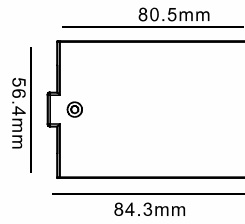

Model No.
产品型号

RA481-WH
RA481-BK
RA481-SL

Colour
产品颜色

White
Black
Silver

Package
装箱数量

1/500
1/500
1/500

Straight Connector Cover / 直线接驳器盖板

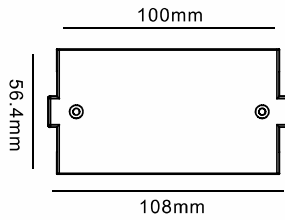

Model No.
产品型号

RA484-WH
RA484-BK
RA484-SL

Colour
产品颜色

White
Black
Silver

Package
装箱数量

1/500
1/500
1/500

"L" Connector Cover / L形接驳器盖板

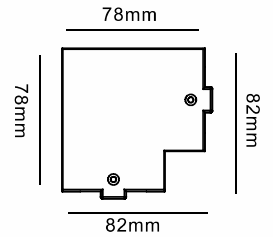

Model No.
产品型号

RA485-WH
RA485-BK
RA485-SL

Colour
产品颜色

White
Black
Silver

Package
装箱数量

1/500
1/500
1/500

"T" Connector Cover / T形接驳器盖板

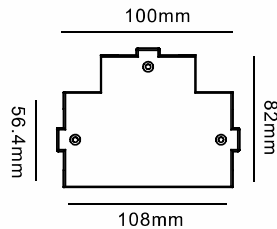

Model No.
产品型号

RA486-WH
RA486-BK
RA486-SL

Colour
产品颜色

White
Black
Silver

Package
装箱数量

1/500
1/500
1/500

"十" Connector Cover / 十字形接驳器盖板

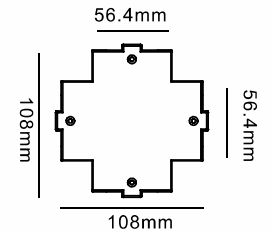

Model No.
产品型号

RA487-WH
RA487-BK
RA487-SL

Colour
产品颜色

White
Black
Silver

Package
装箱数量

1/500
1/500
1/500

4 Wires Track System Application
4线轨道系统应用

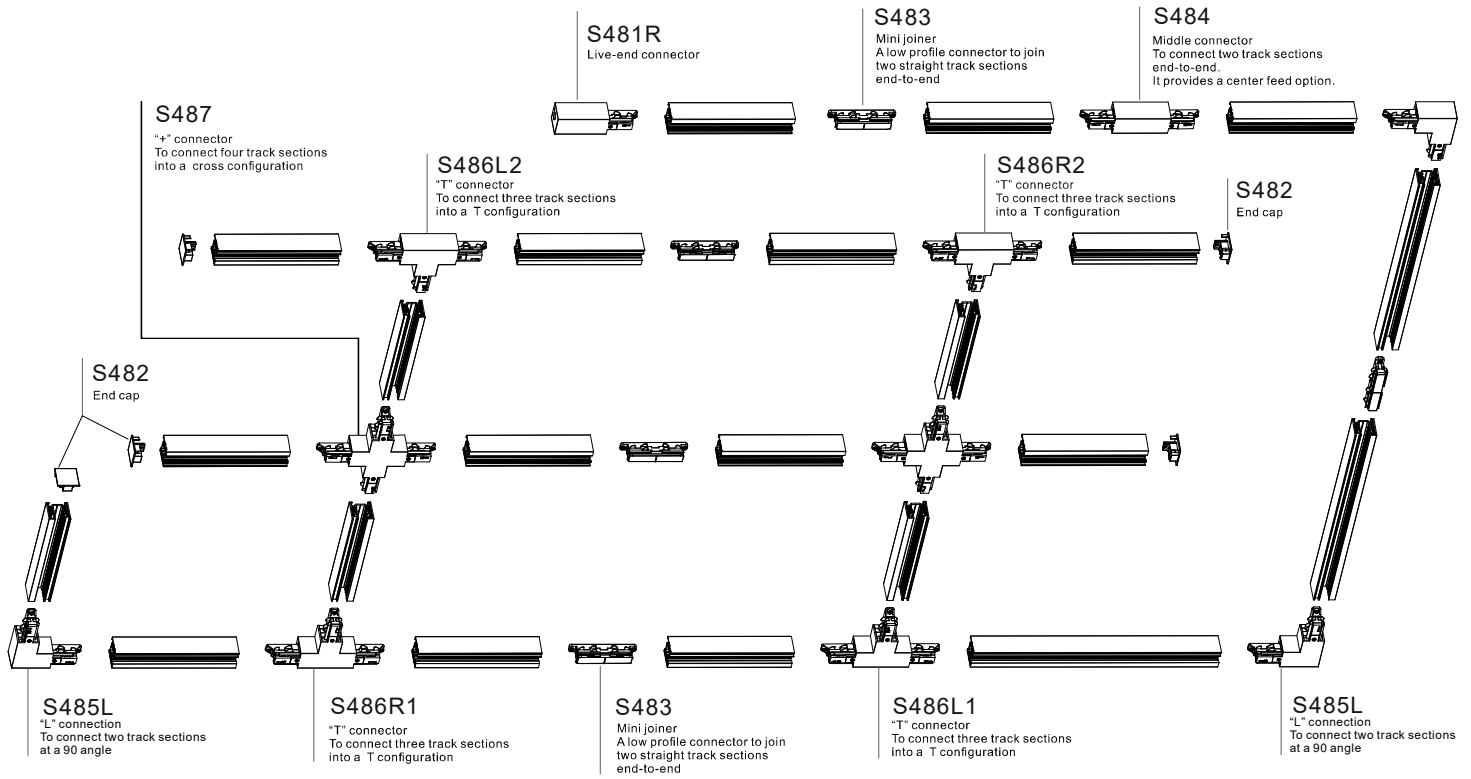

Connection Installation
安装说明

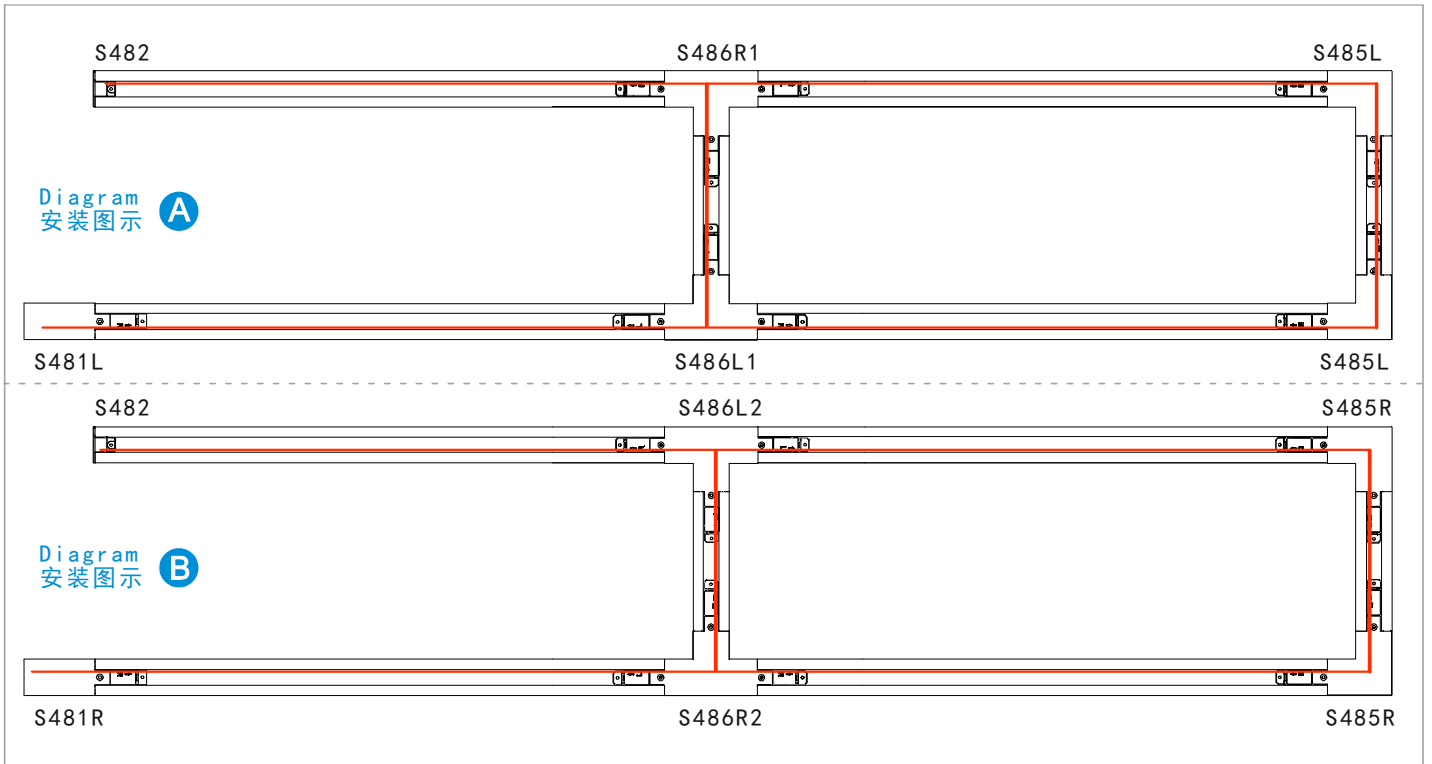

4 Wires 3 Circuits Track System(Deluxe) / 4线三回路轨道系统 (豪华款)

4 Wires 3 Circuits Track (Deluxe) / 4线3回路轨道系统 (豪华款)



Coextrusion Technology of Flat Copper Wire
扁铜线共挤技术
导电弹片与轨道铜线有更多、更安全的接触面

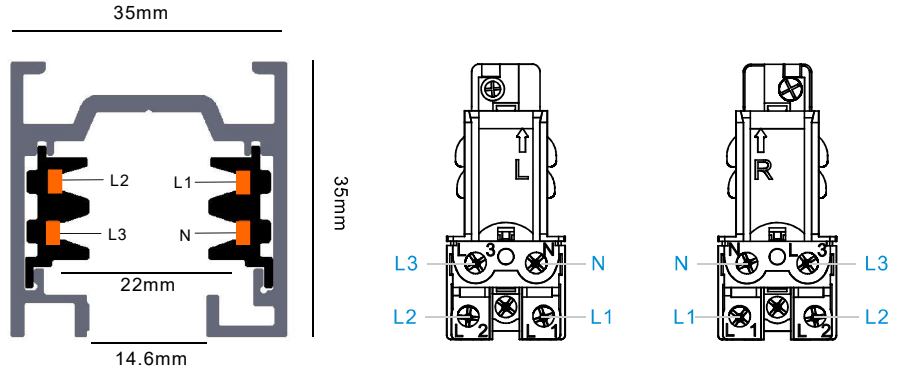

Model No.
产品型号

Track Length
轨道长度

Colour
产品颜色

Package
装箱数量

S410-WH
S410-BK
S410-SL

1000mm
1000mm
1000mm

White
Black
Silver

1 / 12
1 / 12
1 / 12

S420-WH
S420-BK
S420-SL

2000mm
2000mm
2000mm

White
Black
Silver

1 / 12
1 / 12
1 / 12

S430-WH
S430-BK
S430-SL

3000mm
3000mm
3000mm

White
Black
Silver

1 / 8
1 / 8
1 / 8

S440-WH
S440-BK
S440-SL

4000mm
4000mm
4000mm

White
Black
Silver

1 / 6
1 / 6
1 / 6

Fixing Point Dimensions / 轨道孔位尺寸

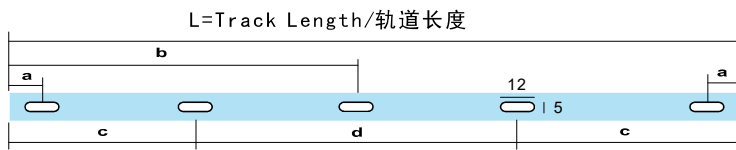

L/mm	a/mm	b/mm	c/mm	d/mm
1000	100			
2000	100	1000		
3000	100		1500	
4000	100		1333	1333

Mechanical Load Diagram / 轨道承重图

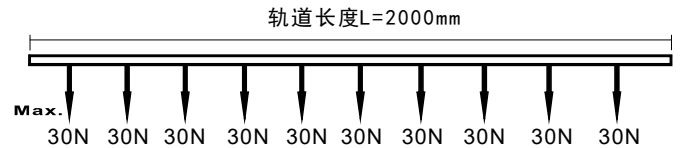
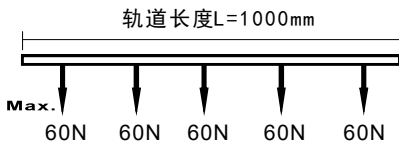

Connecting Diagram / 轨道接线图

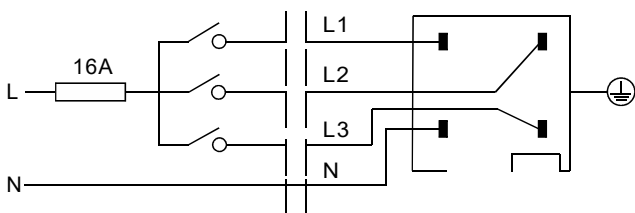

1 Phase / 单相电 230VAC 16A Max

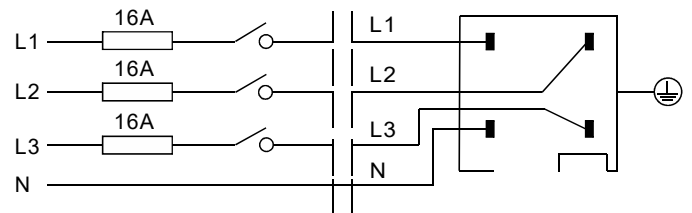

3 Phases / 三相电 230VAC 3x16A Max

4 Wires 3 Circuits Track System(Deluxe) / 4线三回路轨道系统（豪华款）

Track Power Connector (L) / 轨道电源头（左）

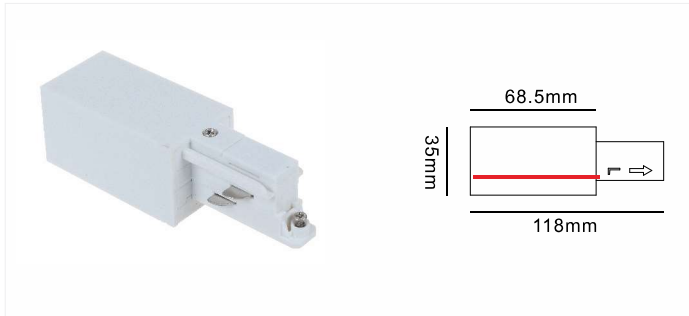

Model No. 产品型号	Colour 产品颜色	Package 装箱数量
S481L-WH	White	1/150
S481L-BK	Black	1/150
S481L-SL	Silver	1/150

Track Power Connector (R) / 轨道电源头（右）

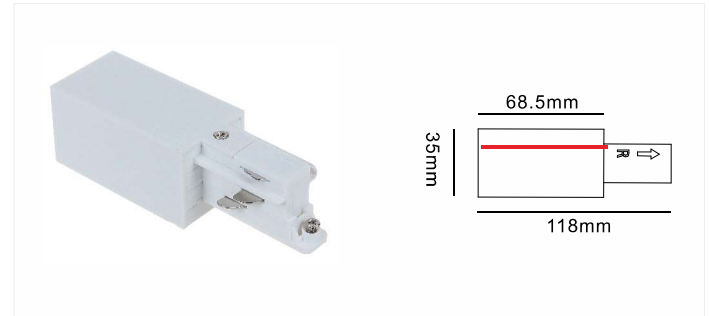

Model No. 产品型号	Colour 产品颜色	Package 装箱数量
S481R-WH	White	1/150
S481R-BK	Black	1/150
S481R-SL	Silver	1/150

End Cap / 尾盖

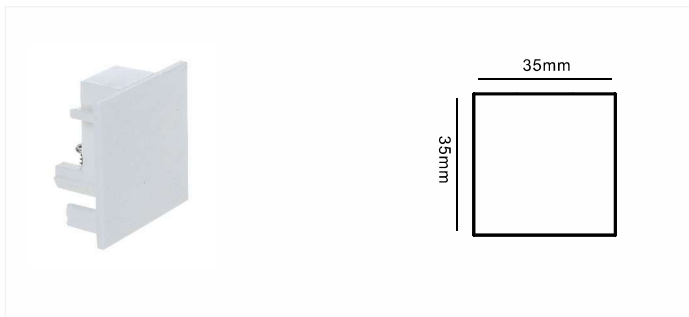

Model No. 产品型号	Colour 产品颜色	Package 装箱数量
S482-WH	White	1/500
S482-BK	Black	1/500
S482-SL	Silver	1/500

Mini Joiner Connector / I形接驳器

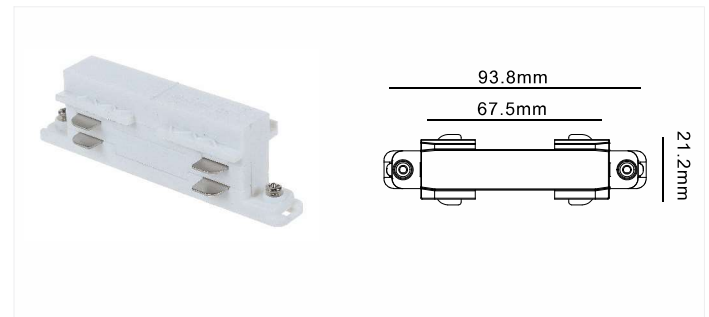

Model No. 产品型号	Colour 产品颜色	Package 装箱数量
S483-WH	White	1/400
S483-BK	Black	1/400
S483-SL	Silver	1/400

Straight Connector / 直线接驳器

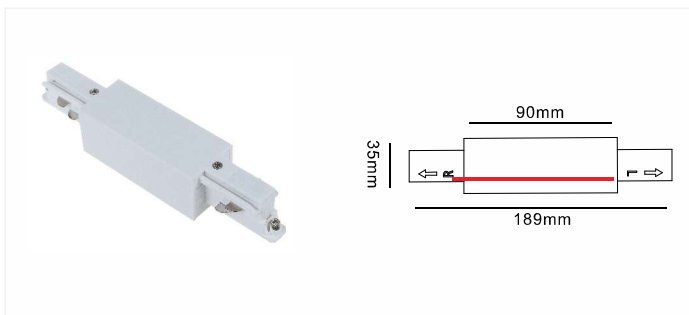

Model No. 产品型号	Colour 产品颜色	Package 装箱数量
S484-WH	White	1/160
S484-BK	Black	1/160
S484-SL	Silver	1/160

“十” Cross Connector / 十字接驳器

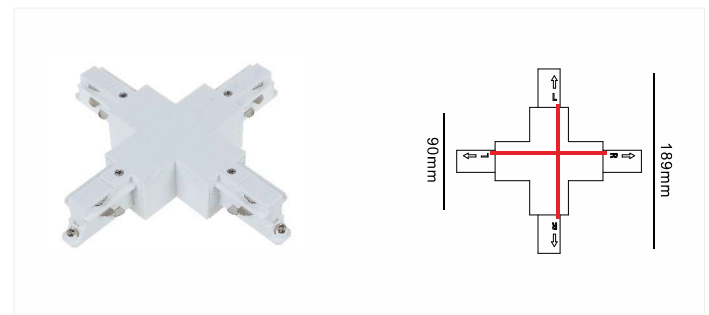

Model No. 产品型号	Colour 产品颜色	Package 装箱数量
S487-WH	White	1/60
S487-BK	Black	1/60
S487-SL	Silver	1/60

“L” Connector (L) / L形接驳器 (左)

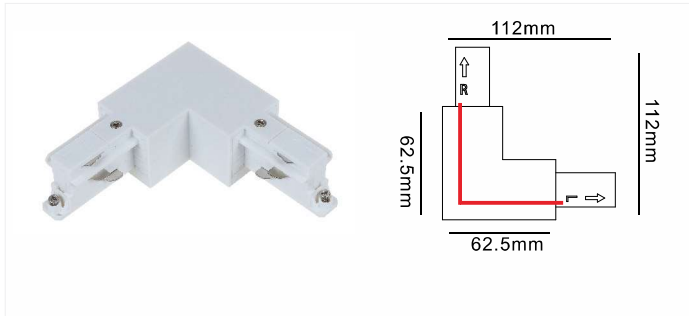

Model No. 产品型号	Colour 产品颜色	Package 装箱数量
S485L-WH	White	1/150
S485L-BK	Black	1/150
S485L-SL	Silver	1/150

“L” Connector (R) / L形接驳器 (右)

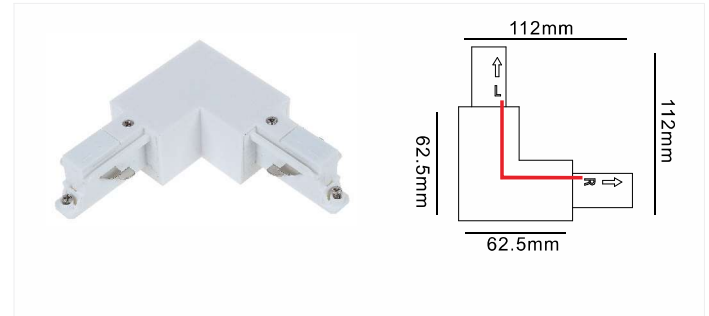

Model No. 产品型号	Colour 产品颜色	Package 装箱数量
S485R-WH	White	1/150
S485R-BK	Black	1/150
S485R-SL	Silver	1/150

“T” Connector (L1) / T形接驳器 (左1)

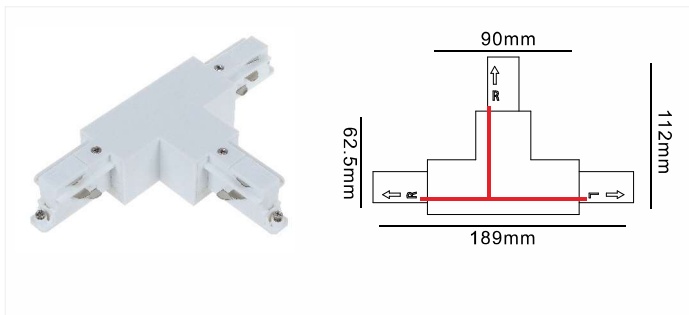

Model No. 产品型号	Colour 产品颜色	Package 装箱数量
S486L1-WH	White	1/90
S486L1-BK	Black	1/90
S486L1-SL	Silver	1/90

“T” Connector (L2) / T形接驳器 (左2)

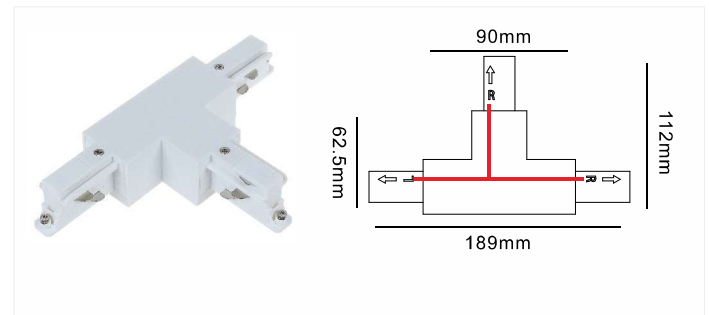

Model No. 产品型号	Colour 产品颜色	Package 装箱数量
S486L2-WH	White	1/90
S486L2-BK	Black	1/90
S486L2-SL	Silver	1/90

“T” Connector (R1) / T形接驳器 (右1)

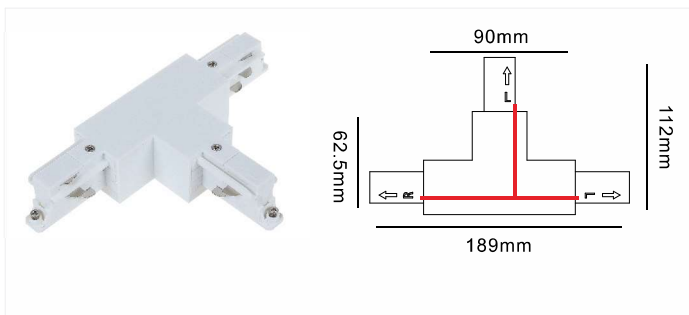

Model No. 产品型号	Colour 产品颜色	Package 装箱数量
S486R1-WH	White	1/90
S486R1-BK	Black	1/90
S486R1-SL	Silver	1/90

“T” Connector (R2) / T形接驳器 (右2)

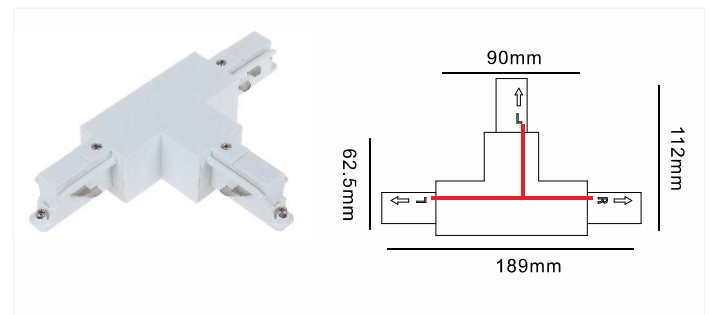

Model No. 产品型号	Colour 产品颜色	Package 装箱数量
S486R2-WH	White	1/90
S486R2-BK	Black	1/90
S486R2-SL	Silver	1/90

4 Wires 3 Circuits Track System(Deluxe) / 4线三回路轨道系统（豪华款）

Twisted Connector / 万向型接驳器

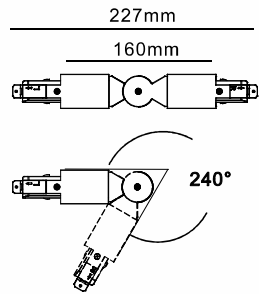

Model No. 产品型号	Colour 产品颜色	Package 装箱数量
S488-WH	White	1/150
S488-BK	Black	1/150
S488-SL	Silver	1/150

Flexible Connector / 软管接驳器



Model No. 产品型号	Colour 产品颜色	Package 装箱数量
S489-WH	White	1/150
S489-BK	Black	1/150
S489-SL	Silver	1/150

Ceiling mount kit / 悬挂吊件组

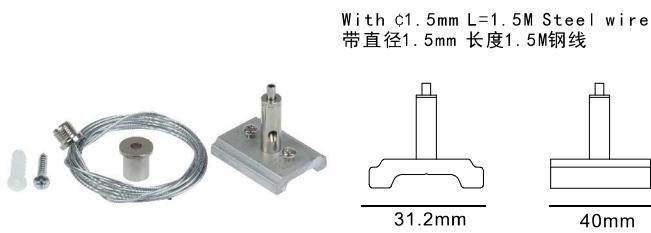

Model No. 产品型号	Colour 产品颜色	Package 装箱数量
S491-WH	White	1/200
S491-BK	Black	1/200
S491-SL	Silver	1/200

Connecting Plate / 连接板

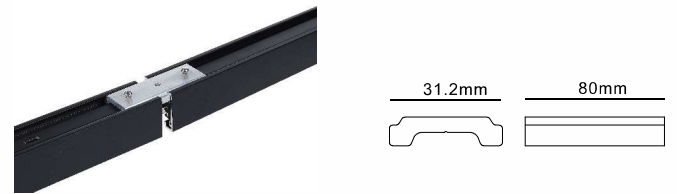

Model No. 产品型号	Colour 产品颜色	Package 装箱数量
S492-WH	White	1/400
S492-BK	Black	1/400
S492-SL	Silver	1/400

Track Suspension Diagram 轨道吊件安装图

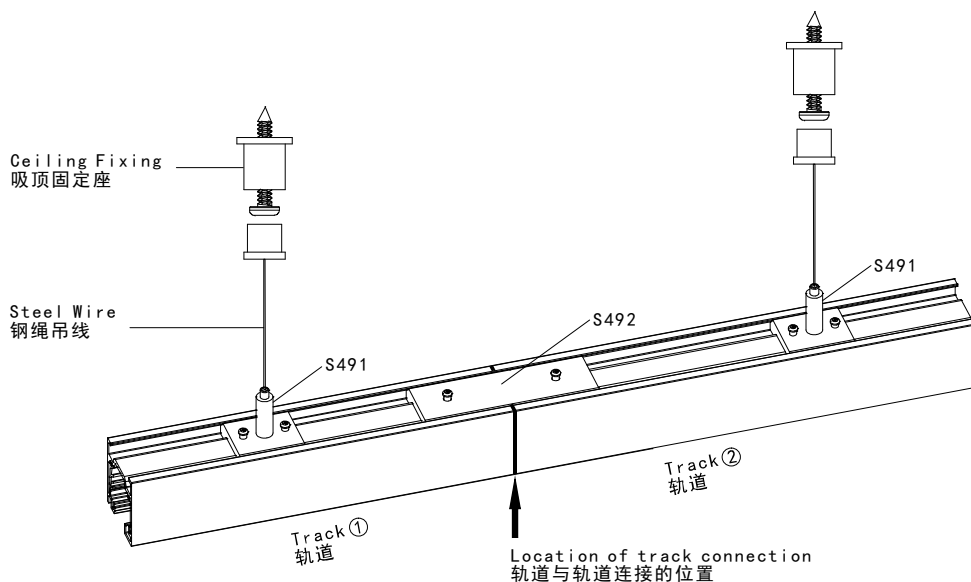

4 Wires 3 Circuits Track System(Deluxe) / 4线三回路轨道系统（豪华款）

4 Wires 3 Circuits Recessed Track(Deluxe) / 4线3回路嵌入式轨道系统（豪华款）

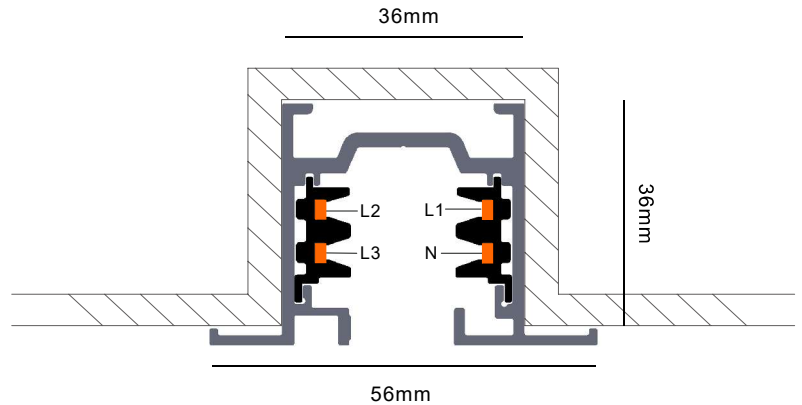

Model No. 产品型号	Track Length 轨道长度	Colour 产品颜色	Package 装箱数量
RS410-WH	1000mm	White	1 / 12
RS410-BK	1000mm	Black	1 / 12
RS410-SL	1000mm	Silver	1 / 12
RS420-WH	2000mm	White	1 / 12
RS420-BK	2000mm	Black	1 / 12
RS420-SL	2000mm	Silver	1 / 12
RS430-WH	3000mm	White	1 / 8
RS430-BK	3000mm	Black	1 / 8
RS430-SL	3000mm	Silver	1 / 8
RS440-WH	4000mm	White	1 / 6
RS440-BK	4000mm	Black	1 / 6
RS440-SL	4000mm	Silver	1 / 6

Fixing Point Dimensions / 轨道孔位尺寸

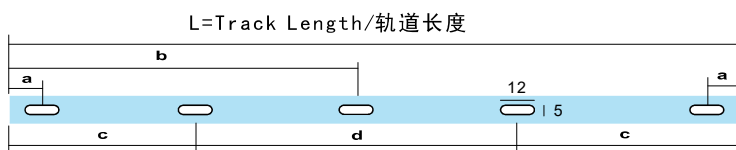

L/mm	a/mm	b/mm	c/mm	d/mm
1000	100			
2000	100	1000		
3000	100		1500	
4000	100		1333	1333

Mechanical Load Diagram / 轨道承重图

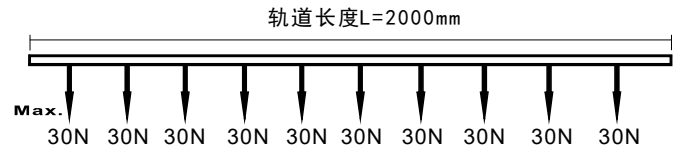
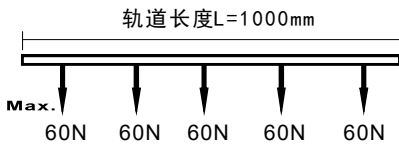

Connecting Diagram / 轨道接线图

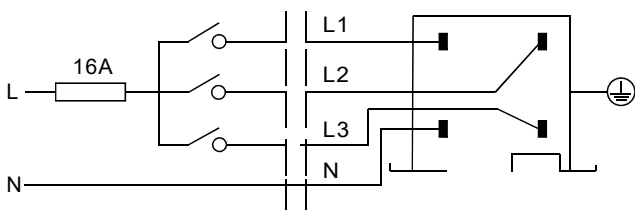

1 Phase / 单相电 230VAC 16A Max

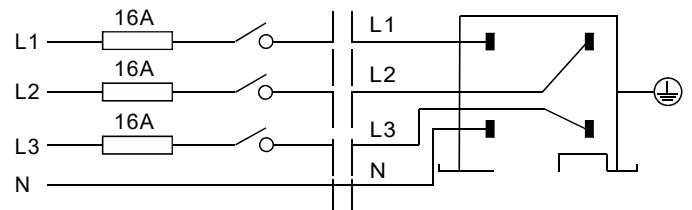

3 Phases / 三相电 230VAC 3x16A Max

4 Wires 3 Circuits Track System(Deluxe) / 4线三回路轨道系统 (豪华款)

Power Connector Cover / 电源头盖板

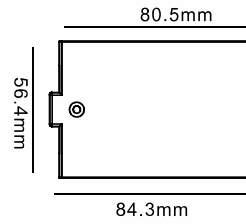

Model No.
产品型号

RS461-WH
RS461-BK
RS461-SL

Colour
产品颜色

White
Black
Silver

Package
装箱数量

1/500
1/500
1/500

Straight Connector Cover / 直线接驳器盖板

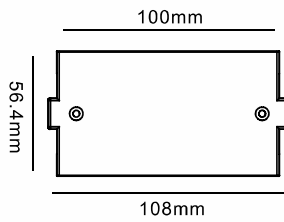

Model No.
产品型号

RS464-WH
RS464-BK
RS464-SL

Colour
产品颜色

White
Black
Silver

Package
装箱数量

1/500
1/500
1/500

"L" Connector Cover / L形接驳器盖板

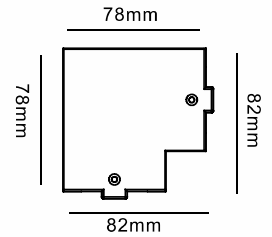

Model No.
产品型号

RS465-WH
RS465-BK
RS465-SL

Colour
产品颜色

White
Black
Silver

Package
装箱数量

1/500
1/500
1/500

"T" Connector Cover / T形接驳器盖板

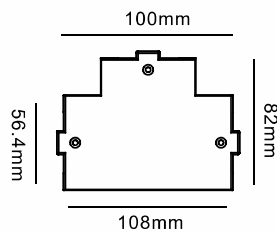

Model No.
产品型号

RS466-WH
RS466-BK
RS466-SL

Colour
产品颜色

White
Black
Silver

Package
装箱数量

1/500
1/500
1/500

"十" Connector Cover / 十字形接驳器盖板

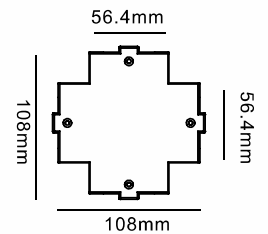

Model No.
产品型号

RS467-WH
RS467-BK
RS467-SL

Colour
产品颜色

White
Black
Silver

Package
装箱数量

1/500
1/500
1/500

4 Wires 3 Circuits Track System / 4线三回路轨道系统

4 Wires 3 Circuits Adaptor

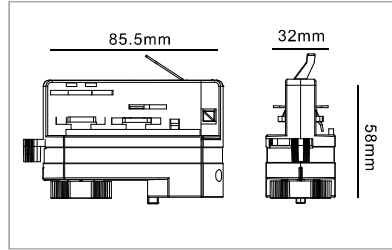

Model No.	Colour	Package
401-WH	White	1/200
401-BK	Black	1/200
401-SL	Silver	1/200

4 Wires 3 Circuits Adaptor (Small)

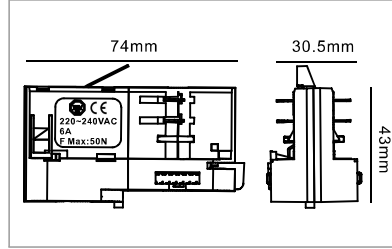
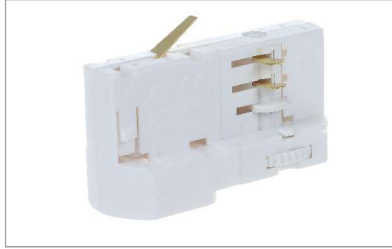

Model No.	Colour	Package
402-WH	White	1/300
402-BK	Black	1/300
402-SL	Silver	1/300

4 Wires 3 Circuits Gearbox (Big)

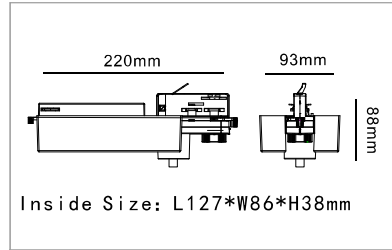

Model No.	Colour	Package
451-WH	White	1/60
451-BK	Black	1/60
451-SL	Silver	1/60

4 Wires 3 Circuits Gearbox (Small)

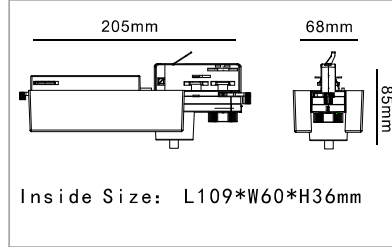
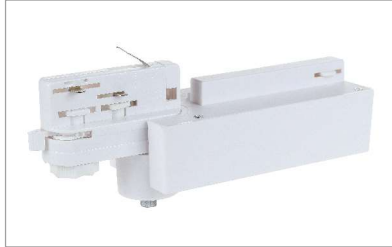

Model No.	Colour	Package
452-WH	White	1/80
452-BK	Black	1/80
452-SL	Silver	1/80

Adaptor Nipple Connector (Public)



471-H05
M10 x 5mm



471-H08
M10 x 8mm



471-H12
M10 x 12mm



474-H08
M10 x 8mm



471-H12
M10 x 12mm

3 Wires Single Phase Track System / 3线单回路轨道系统

3 Wires Track System / 3线轨道系统安装效果图

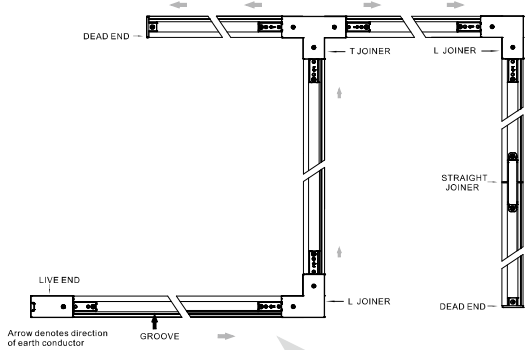

Applications

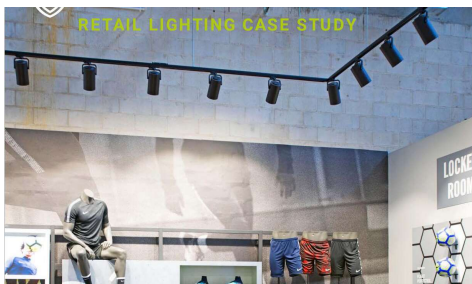
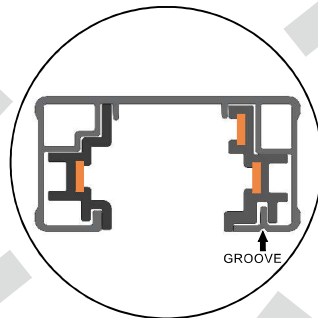

Track has a groove running along its face. This denotes the "Earth" side of the track.

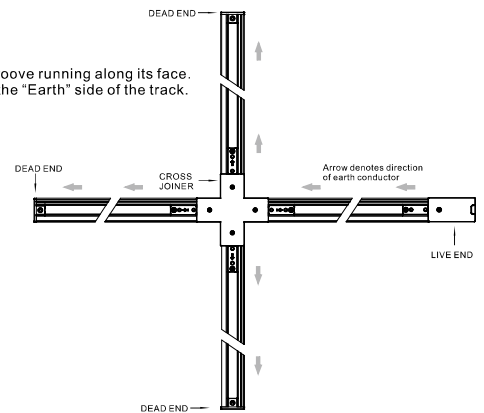

Connecting Diagram / 轨道接线图

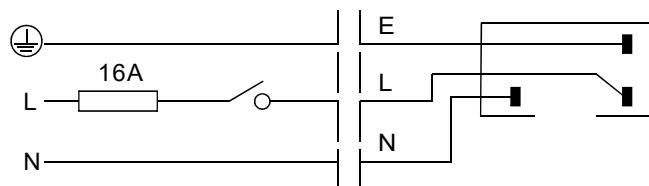

1 Phase / 单相电 120V/230V AC 16A Max

3 Wires Single Phase Track System / 3线单回路轨道系统

Track System Application 轨道系统应用

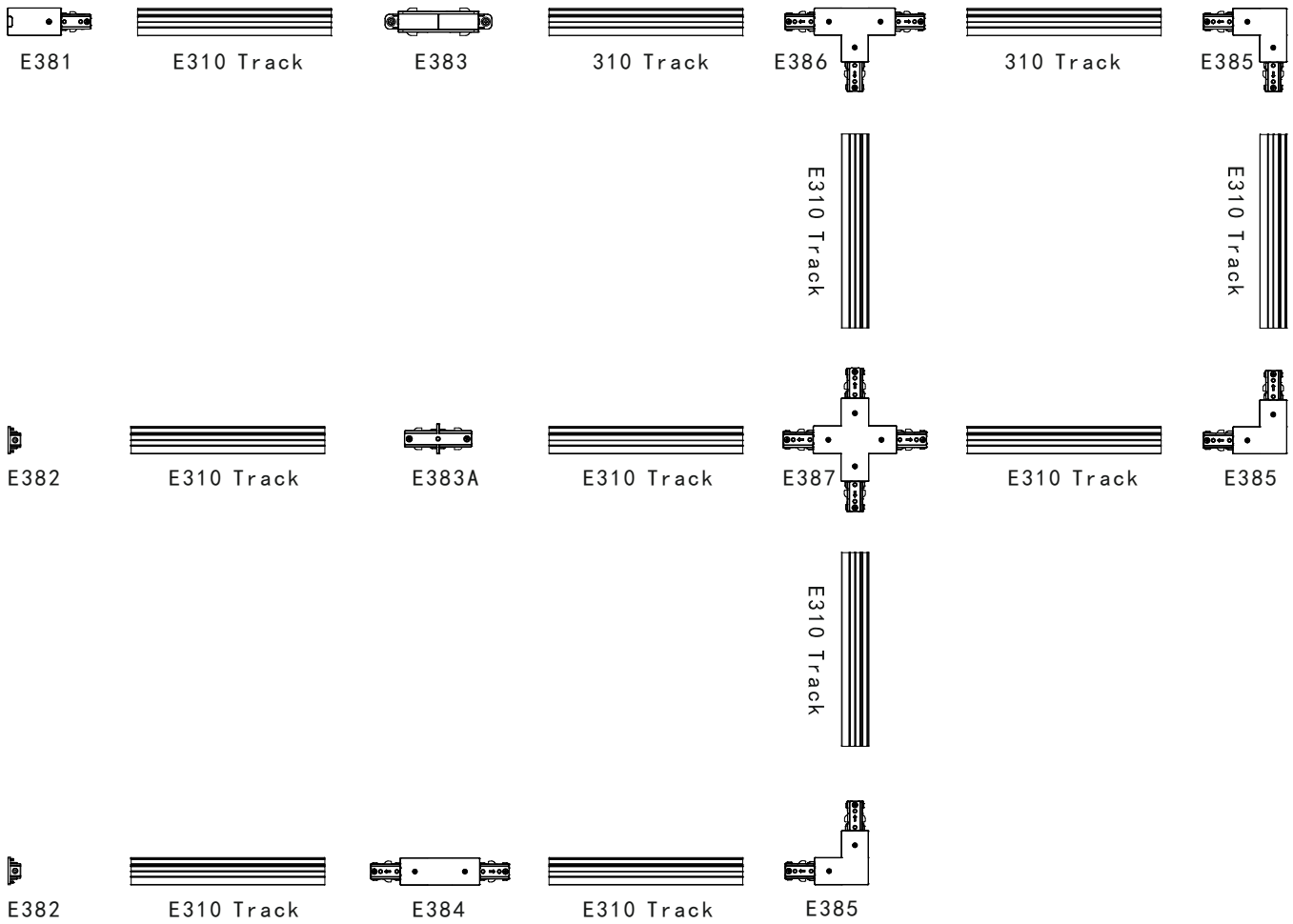

Track Fix 轨道固定方式

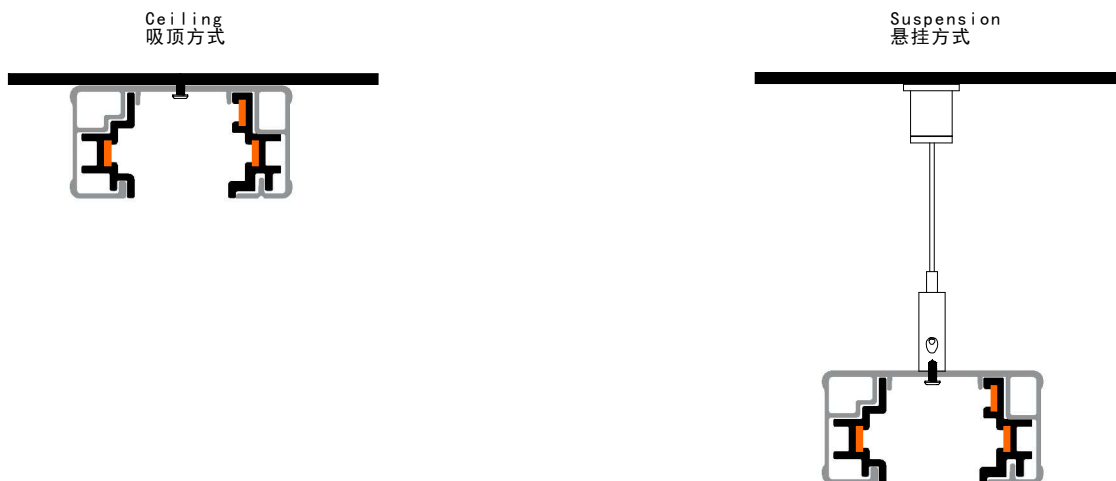

3 Wires Single Phase Track System / 3线单回路轨道系统

3 Wires Single Phase Track / 3线单回路轨道



Coextrusion Technology of Flat Copper Wire
扁铜线共挤技术
导电弹片与轨道铜线有更多、更安全的接触面

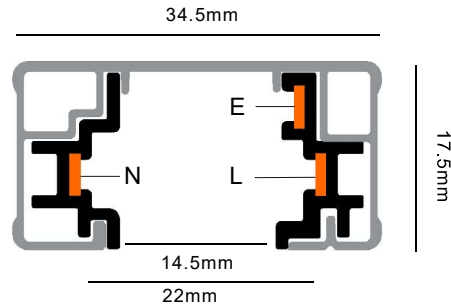

Model No. 产品型号	Specifications 规格	Track Length 轨道长度	Colour 产品颜色	Package 装箱数量
E310A-WH	With Power Connector and End Cap/轨道含头尾	1000mm	White	1 / 20
E310A-BK	With Power Connector and End Cap/轨道含头尾	1000mm	Black	1 / 20
E320A-WH	With Power Connector and End Cap/轨道含头尾	2000mm	White	1 / 20
E320A-BK	With Power Connector and End Cap/轨道含头尾	2000mm	Black	1 / 20
E330A-WH	With Power Connector and End Cap/轨道含头尾	3000mm	White	1 / 20
E330A-BK	With Power Connector and End Cap/轨道含头尾	3000mm	Black	1 / 20
E340A-WH	With Power Connector and End Cap/轨道含头尾	4000mm	White	1 / 20
E340A-BK	With Power Connector and End Cap/轨道含头尾	4000mm	Black	1 / 20
E310B-WH	Only Track / 轨道足米	1000mm	White	1 / 20
E310B-BK	Only Track / 轨道足米	1000mm	Black	1 / 20
E320B-WH	Only Track / 轨道足米	2000mm	White	1 / 20
E320B-BK	Only Track / 轨道足米	2000mm	Black	1 / 20
E330B-WH	Only Track / 轨道足米	3000mm	White	1 / 20
E330B-BK	Only Track / 轨道足米	3000mm	Black	1 / 20
E340B-WH	Only Track / 轨道足米	4000mm	White	1 / 20
E340B-BK	Only Track / 轨道足米	4000mm	Black	1 / 20

Fixing Point Dimensions / 轨道孔位尺寸

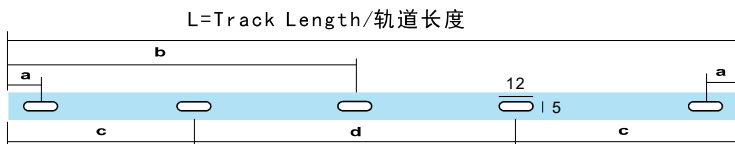

L/mm	a/mm	b/mm	c/mm	d/mm
1000	100			
2000	100	1000		
3000	100		1500	
4000	100		1333	1333

3 Wires Single Phase Track System / 3线单回路轨道系统

Track Power Connector / 轨道电源头

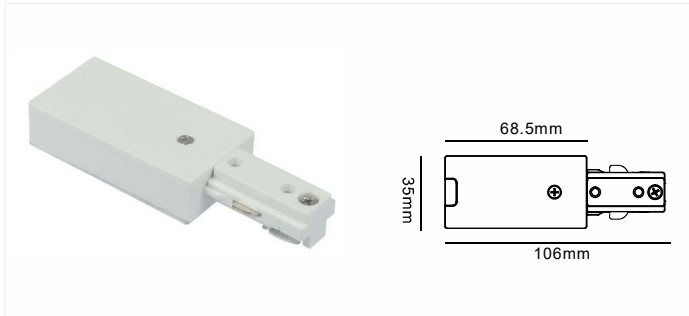

Model No. 产品型号	Colour 产品颜色	Package 装箱数量
E381-WH	White	1/150
E381-BK	Black	1/150

End Cap / 尾盖

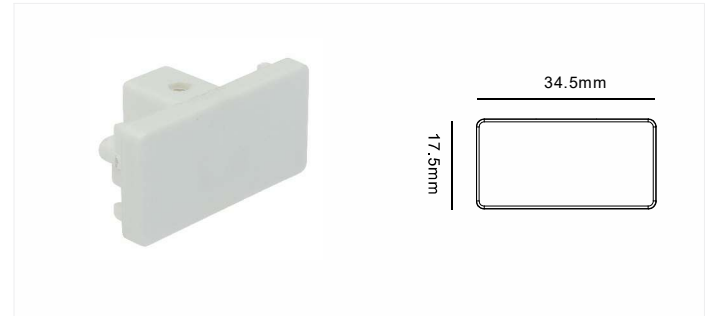

Model No. 产品型号	Colour 产品颜色	Package 装箱数量
E382-WH	White	1/150
E382-BK	Black	1/150

Mini Joiner Connector / I形接驳器

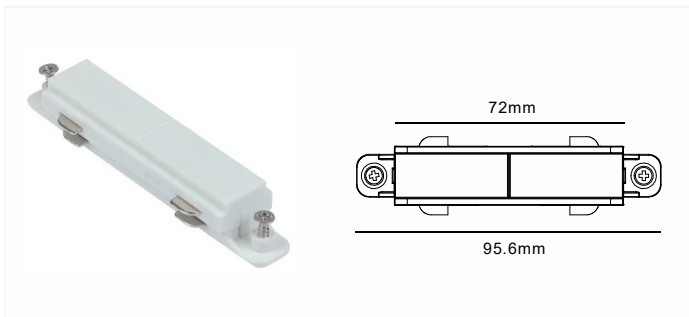

Model No. 产品型号	Colour 产品颜色	Package 装箱数量
E383-WH	White	1/400
E383-BK	Black	1/400

Mini Joiner Connector / I形接驳器

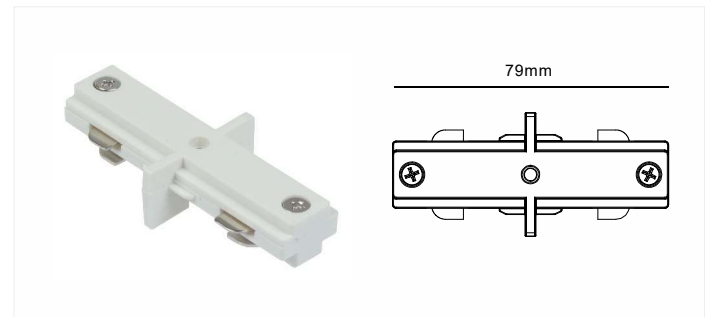

Model No. 产品型号	Colour 产品颜色	Package 装箱数量
E383A-WH	White	1/400
E383A-BK	Black	1/400

Straight Connector / 直线接驳器

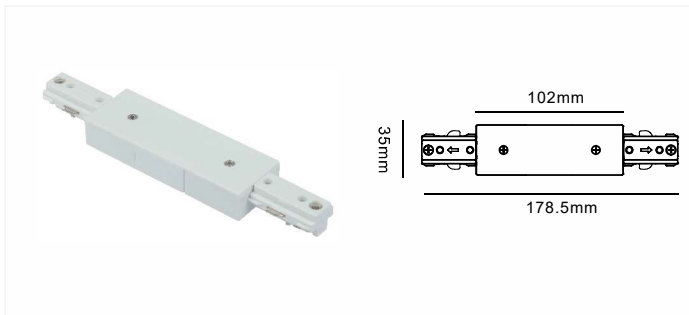

Model No. 产品型号	Colour 产品颜色	Package 装箱数量
E384-WH	White	1/160
E384-BK	Black	1/160

"L" Connector / L形接驳器

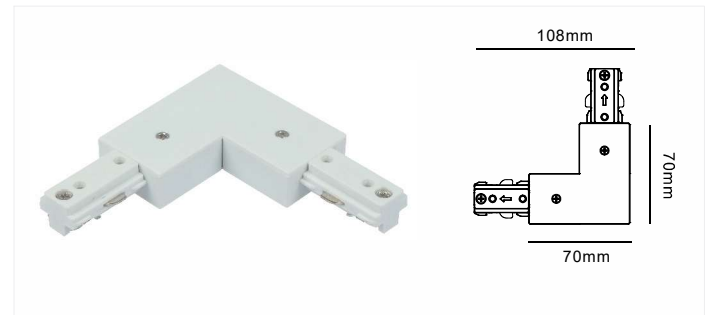

Model No. 产品型号	Colour 产品颜色	Package 装箱数量
E385-WH	White	1/150
E385-BK	Black	1/150

3 Wires Single Phase Track System / 3线单回路轨道系统



“T” Connector / T形接驳器

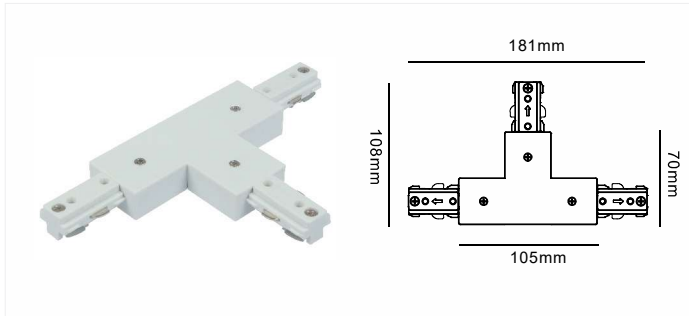

Model No. 产品型号	Colour 产品颜色	Package 装箱数量
E386-W	White	1/90
E386-B	Black	1/90

“十” Cross Connector / 十字接驳器

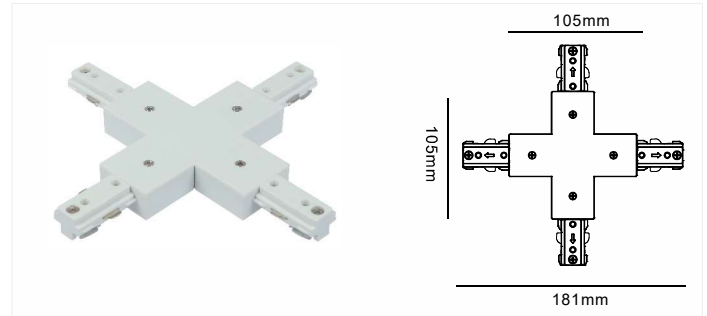

Model No. 产品型号	Colour 产品颜色	Package 装箱数量
E387-W	White	1/60
E387-B	Black	1/60

Ceiling mount kit / 悬挂吊件组

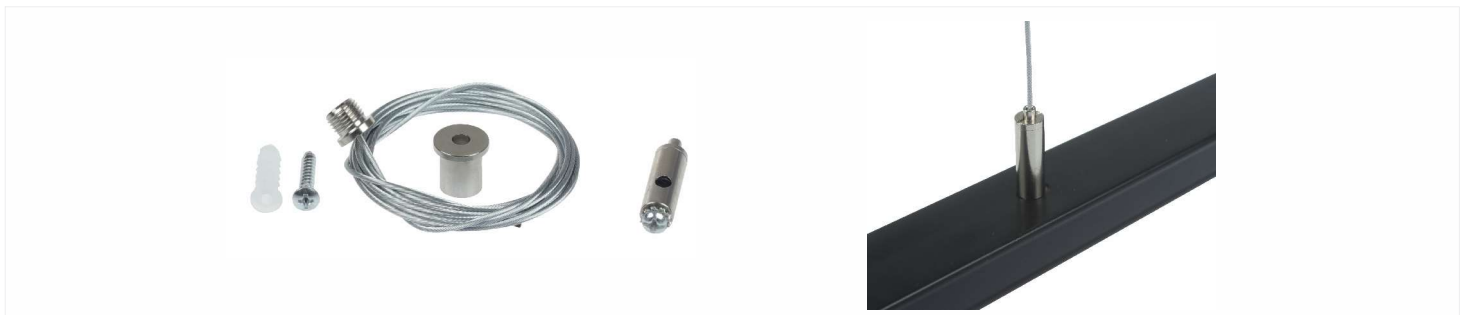

Model No. 产品型号	Colour 产品颜色	Package 装箱数量
E391	Nickel (镍色)	1/500

Track Suspension Diagram 轨道吊件安装图

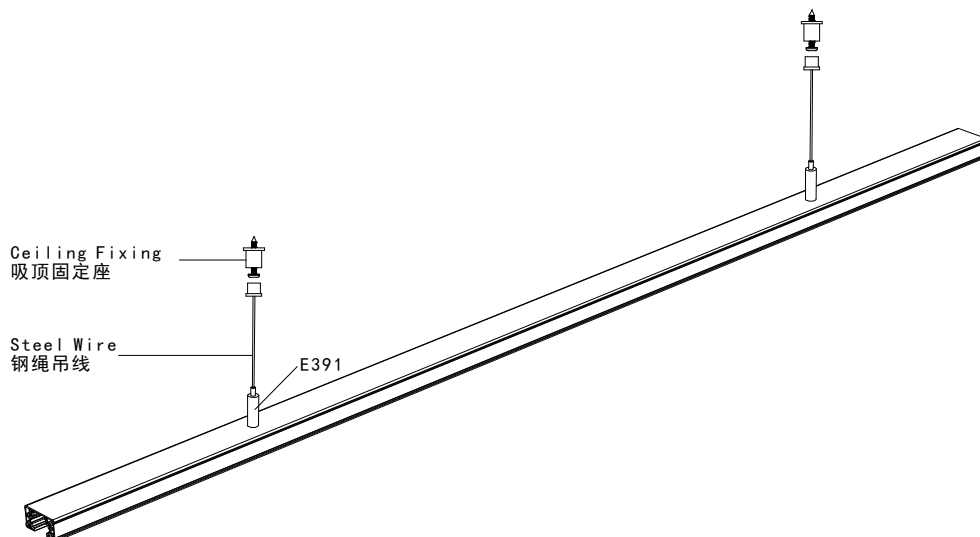

3 Wires Single Phase Track System / 3线单回路轨道系统

3 Wires Adaptor

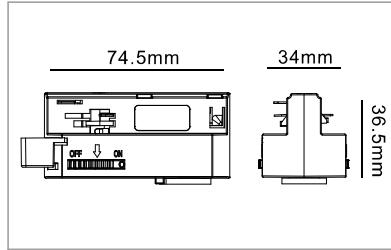

Model No.	Colour	Package
301-WH	White	1/300
301-BK	Black	1/300
301-SL	Silver	1/300

3 Wires Adaptor (Small)

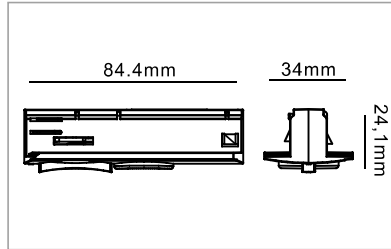

Model No.	Colour	Package
302-WH	White	1/500
302-BK	Black	1/500
302-SL	Silver	1/500

3 Wires Adaptor (Square)

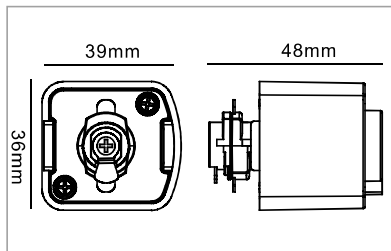

Model No.	Colour	Package
303-WH	White	1/300
303-BK	Black	1/300
303-SL	Silver	1/300

3 Wires Gearbox (Big)

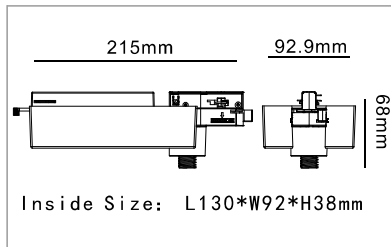

Model No.	Colour	Package
351-WH	White	1/60
351-BK	Black	1/60
351-SL	Silver	1/60

3 Wires Gearbox (Small)

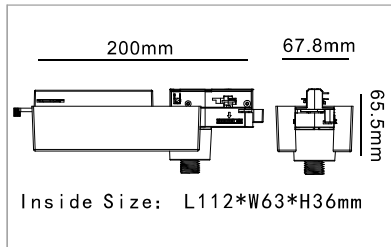

Model No.	Colour	Package
352-WH	White	1/80
352-BK	Black	1/80
352-SL	Silver	1/80

2 Wires Single Phase Track System / 2线单回路轨道系统

2 Wires Adaptor

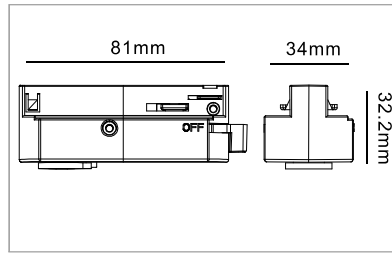

Model No.

201-WH
201-BK
201-SL

Colour

White
Black
Silver

Package

1/300
1/300
1/300

2 Wires Adaptor (Small)

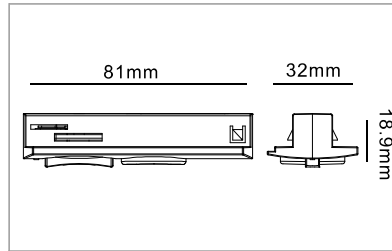

Model No.

202-WH
202-BK
202-SL

Colour

White
Black
Silver

Package

1/500
1/500
1/500

2 Wires Gearbox (Big)

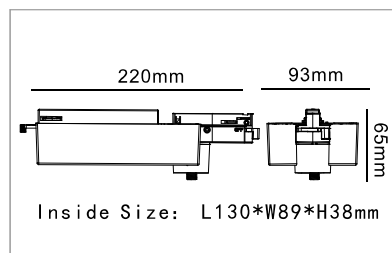

Model No.

251-WH
251-BK
251-SL

Colour

White
Black
Silver

Package

1/60
1/60
1/60

2 Wires Gearbox (Small)

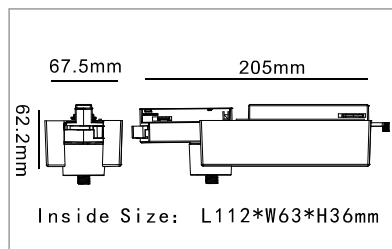

Model No.

252-WH
252-BK
252-SL

Colour

White
Black
Silver

Package

1/80
1/80
1/80

48V Low Voltage Magnet Track System / 无主灯安装效果图

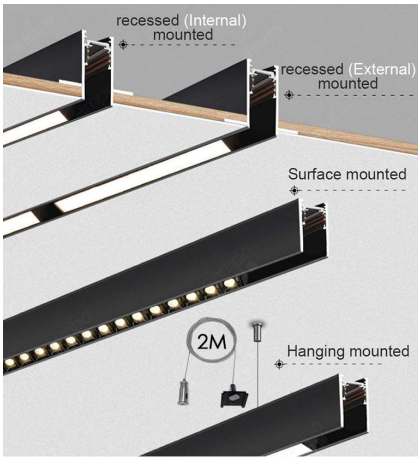

Applications



Applications



Applications

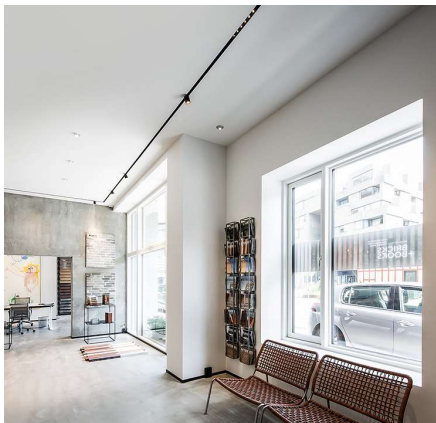
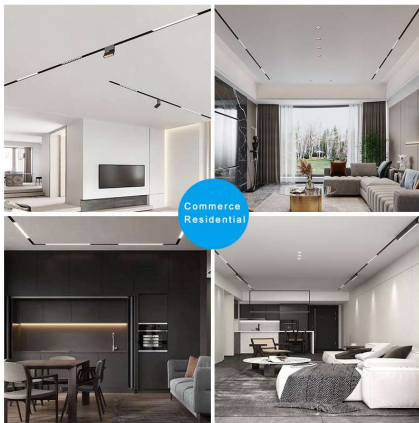

Connecting Diagram / 轨道接线图

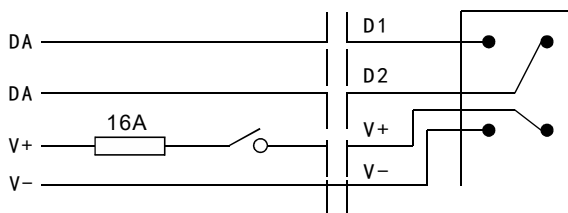

1 Phases / 低电压1~48V 16A Max+ DALI信号线

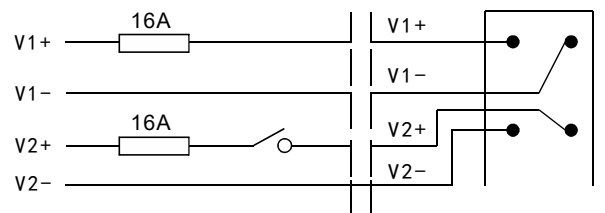

2 Phases / 低电压1~48V 2x16A Max+ DALI信号线

M20 Low Voltage Magnet Track System / M20 低压磁吸轨道系统

M20 Magnet Track (Surface Mounted) / M20 磁吸轨道 (明装款)

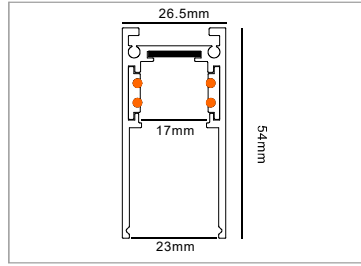
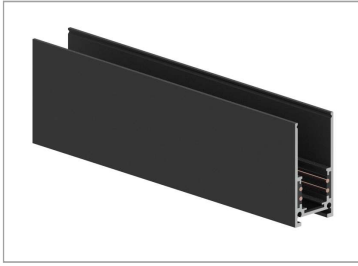

Model No. 产品型号	Track Length 轨道长度	Colour 产品颜色	Package 装箱数量
M20A-10-WH M20A-10-BK	100CM 100CM	White/砂白色 Black/砂黑色	1 / 10 1 / 10
M20A-15-WH M20A-15-BK	150CM 150CM	White/砂白色 Black/砂黑色	1 / 10 1 / 10
M20A-20-WH M20A-20-BK	200CM 200CM	White/砂白色 Black/砂黑色	1 / 10 1 / 10
M20A-30-WH M20A-30-BK	300CM 300CM	White/砂白色 Black/砂黑色	1 / 8 1 / 8

M20 Magnet Track Connector (Surface Mounted) / M20 磁吸轨道接驳器 (明装款)

"L" Connector (Horizontal Direction) / L型接驳器 (水平方向)

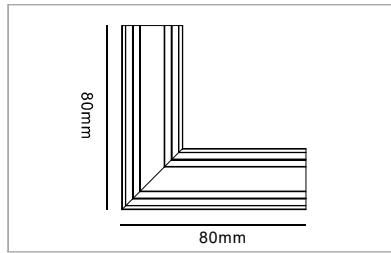
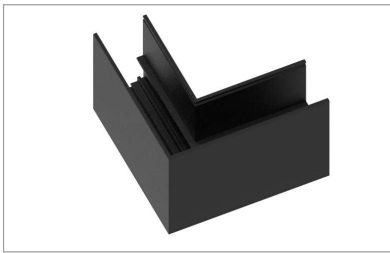

Model No.
产品型号

M211-20A-WH
M211-20A-BK

Colour
颜色

White/砂白色
Black/砂黑色

"L" Connector (Vertical Direction) / L型接驳器 (垂直方向)

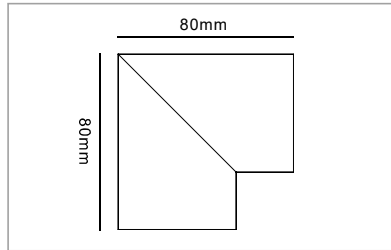

Model No.
产品型号

M212-20A-WH
M212-20A-BK

Colour
颜色

White/砂白色
Black/砂黑色

Installation / 安装说明

Fix
固定方式

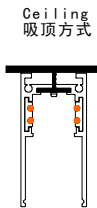

Suspension
悬挂方式

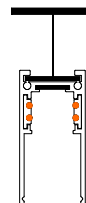

Magnet Track hole dimensions
磁吸轨道冲孔位置图

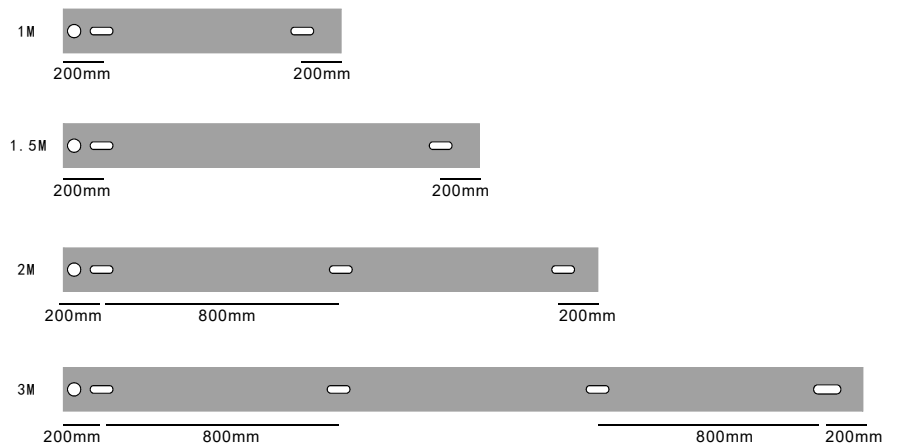

M20 Low Voltage Magnet Track System / M20 低压磁吸轨道系统

M20 Magnet Track (Trimless Recessed) / M20 磁吸轨道 (外装嵌入款)

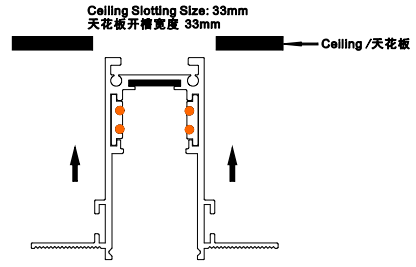
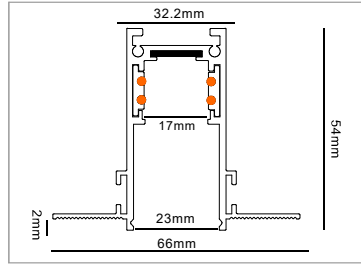
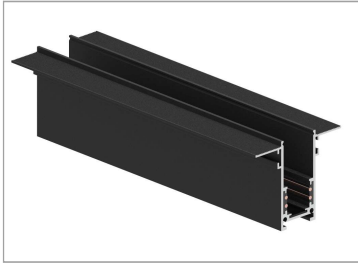

Model No.

产品型号
M20B-10-WH
M20B-10-BK

Track Length

轨道长度
100CM
100CM

Colour

产品颜色
White/砂白色
Black/砂黑色

Package

装箱数量
1 / 12
1 / 12

M20B-15-WH
M20B-15-BK

150CM
150CM

White/砂白色
Black/砂黑色

1 / 12
1 / 12

M20B-20-WH
M20B-20-BK

200CM
200CM

White/砂白色
Black/砂黑色

1 / 12
1 / 12

M20B-30-WH
M20B-30-BK

300CM
300CM

White/砂白色
Black/砂黑色

1 / 8
1 / 8

M20 Magnet Track Connector (Trimless Recessed) / M20磁吸轨道接驳器(外装嵌入款)

"L" Connector (Horizontal Direction) / L型接驳器(水平方向)

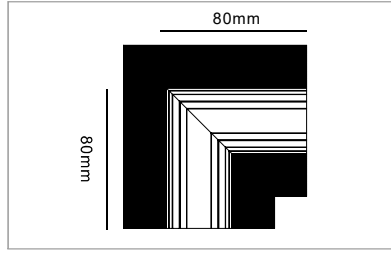
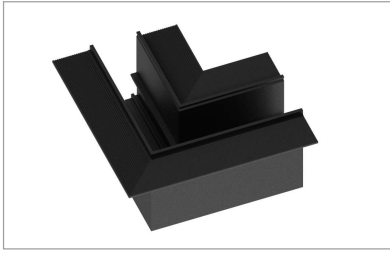

Model No.
产品型号

M211-20B-WH
M211-20B-BK

Colour
颜色

White/砂白色
Black/砂黑色

"L" Connector (Vertical Direction) / L型接驳器(垂直方向)

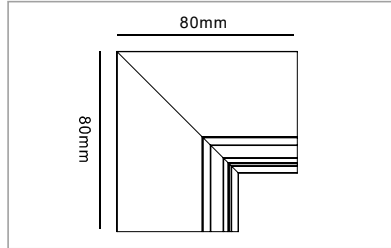

Model No.
产品型号

M212-20B-WH
M212-20B-BK

Colour
颜色

White/砂白色
Black/砂黑色

Installation / 安装说明

Fix
固定方式

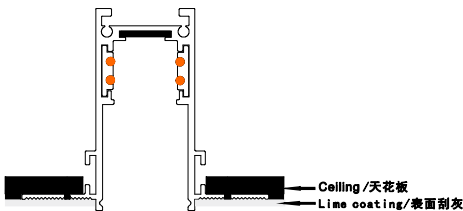

Magnet Track hole dimensions
磁吸轨道冲孔位置图

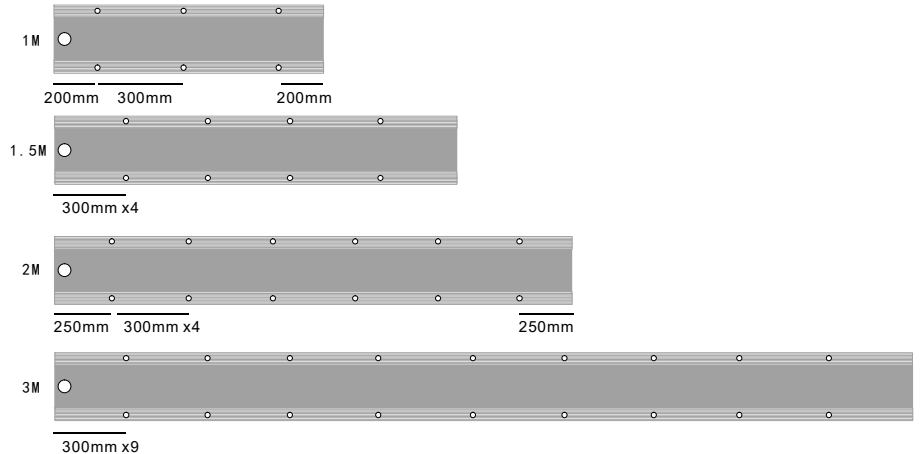

M20 Low Voltage Magnet Track System / M20 低压磁吸轨道系统

M20 Magnet Track (Trimless Embedded) / M20 磁吸轨道 (预埋嵌入款)

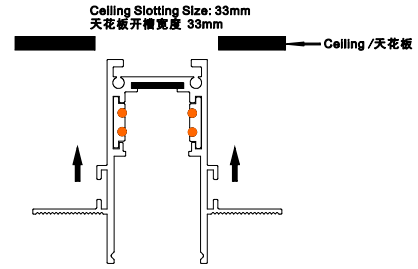
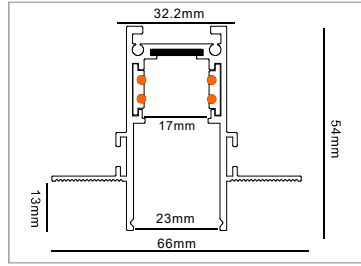
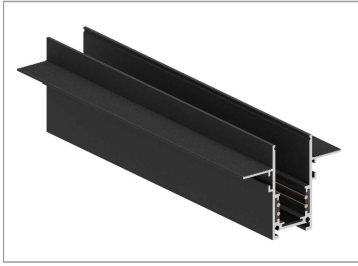

Model No.

产品型号
M20C-10-WH
M20C-10-BK

Track Length

轨道长度
100CM
100CM

Colour

产品颜色
White/砂白色
Black/砂黑色

Package

装箱数量
1 / 12
1 / 12

M20C-15-WH
M20C-15-BK

150CM
150CM

White/砂白色
Black/砂黑色

1 / 12
1 / 12

M20C-20-WH
M20C-20-BK

200CM
200CM

White/砂白色
Black/砂黑色

1 / 12
1 / 12

M20C-30-WH
M20C-30-BK

300CM
300CM

White/砂白色
Black/砂黑色

1 / 8
1 / 8

M20 Magnet Track Connector (Trimless Embedded) / M20 磁吸轨道接驳器(预埋嵌入款)

"L" Connector (Horizontal Direction) / L型接驳器(水平方向)

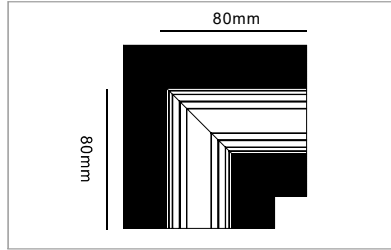
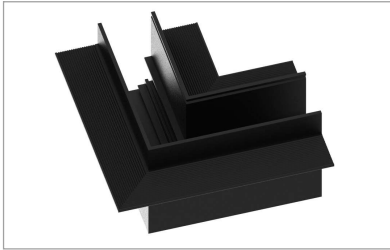

Model No.
产品型号

M211-20C-WH
M211-20C-BK

Colour
颜色

White/砂白色
Black/砂黑色

"L" Connector (Vertical Direction) / L型接驳器(垂直方向)

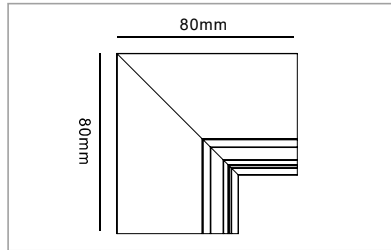

Model No.
产品型号

M212-20C-WH
M212-20C-BK

Colour
颜色

White/砂白色
Black/砂黑色

Installation / 安装说明

Fix
固定方式

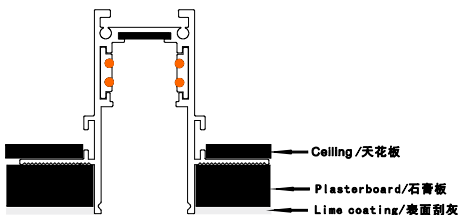

Magnet Track hole dimensions
磁吸轨道冲孔位置图

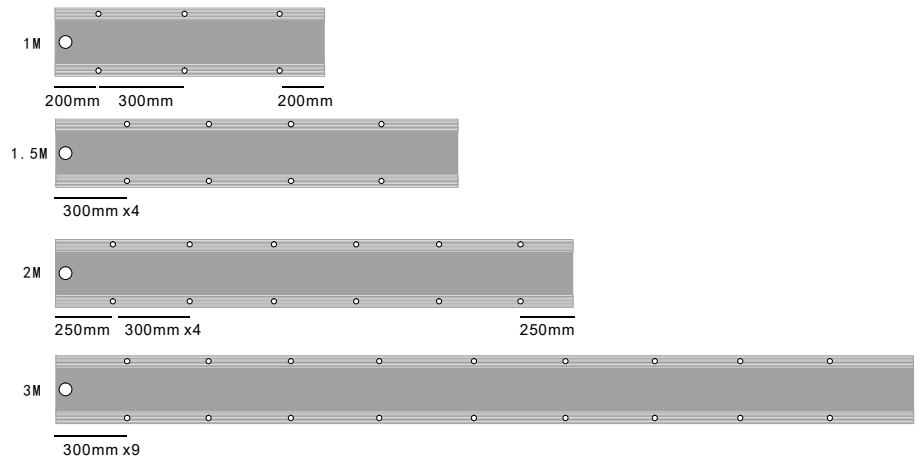

M20 Low Voltage Magnet Track System / M20 低压磁吸轨道系统

M20 Magnet Track (Recessed with Frame) / M20 磁吸轨道 (有边框嵌入款)

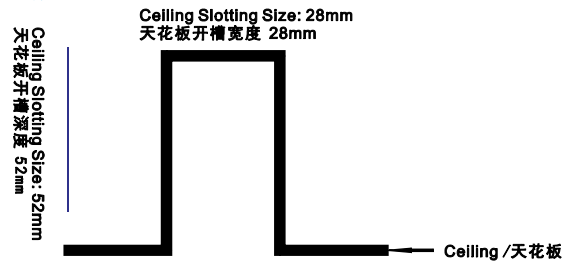
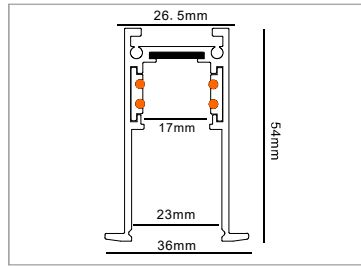
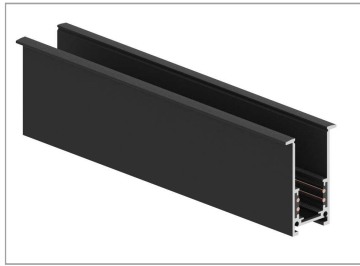

Model No.

产品型号
M20D-10-WH
M20D-10-BK

Track Length

轨道长度
100CM
100CM

Colour

产品颜色
White/砂白色
Black/砂黑色

Package

装箱数量
1 / 15
1 / 15

M20D-15-WH
M20D-15-BK

150CM
150CM

White/砂白色
Black/砂黑色

1 / 15
1 / 15

M20D-20-WH
M20D-20-BK

200CM
200CM

White/砂白色
Black/砂黑色

1 / 15
1 / 15

M20D-30-WH
M20D-30-BK

300CM
300CM

White/砂白色
Black/砂黑色

1 / 8
1 / 8

M20 Magnet Track Connector (Recessed with Frame) / M20 磁吸轨道接驳器(有边框嵌入款)

“L” Connector (Horizontal Direction) / L型接驳器(水平方向)

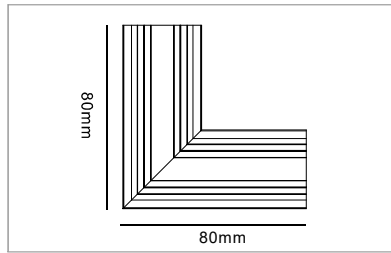

Model No.
产品型号

M211-20D-WH
M211-20D-BK

Colour
颜色

White/砂白色
Black/砂黑色

“L” Connector (Vertical Direction) / L型接驳器(垂直方向)

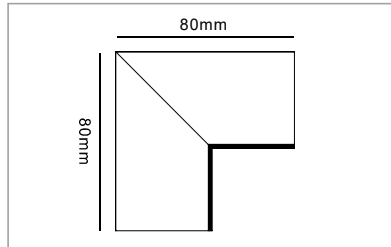

Model No.
产品型号

M212-20D-WH
M212-20D-BK

Colour
颜色

White/砂白色
Black/砂黑色

Installation / 安装说明

Fix
固定方式

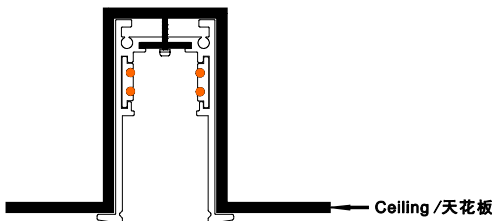

Magnet Track hole dimensions
磁吸轨道冲孔位置图

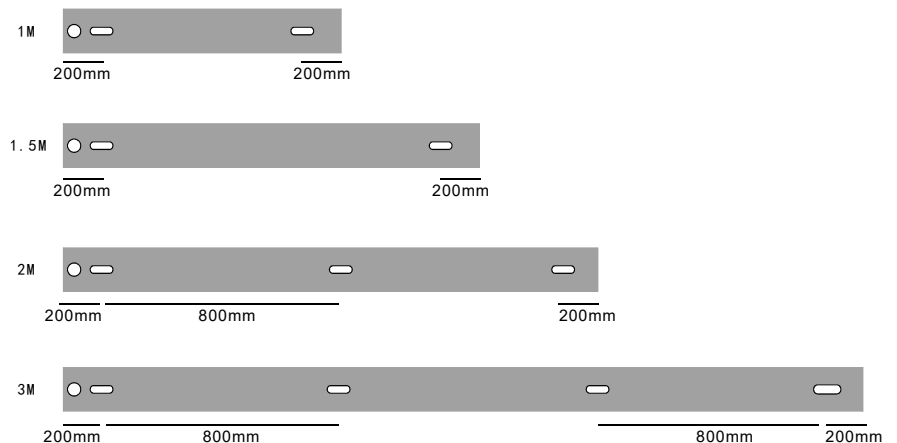

M20 Low Voltage Magnet Track System / M20 低压磁吸轨道系统

M20 Magnet Track (Trimless Embedded) / M20 磁吸轨道 (预埋防裂边嵌入款)

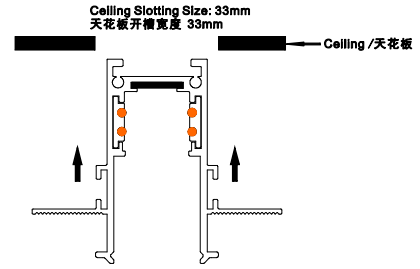
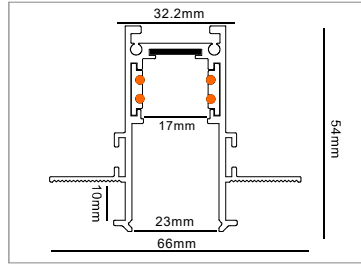
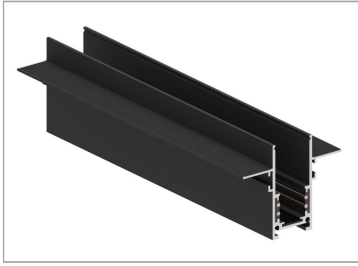

Model No.

产品型号
M20E-10-WH
M20E-10-BK

Track Length

轨道长度
100CM
100CM

Colour

产品颜色
White/砂白色
Black/砂黑色

Package

装箱数量
1 / 12
1 / 12

M20E-15-WH
M20E-15-BK

150CM
150CM

White/砂白色
Black/砂黑色

1 / 12
1 / 12

M20E-20-WH
M20E-20-BK

200CM
200CM

White/砂白色
Black/砂黑色

1 / 12
1 / 12

M20E-30-WH
M20E-30-BK

300CM
300CM

White/砂白色
Black/砂黑色

1 / 8
1 / 8

M20 Magnet Track Connector (Trimless Embedded) / M20 磁吸轨道接驳器 (预埋嵌入款)

"L" Connector (Horizontal Direction) / L型接驳器 (水平方向)

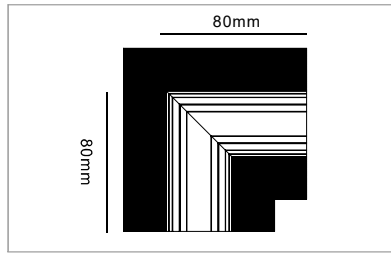
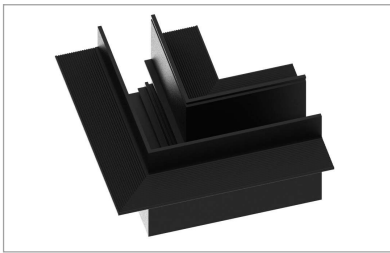

Model No.
产品型号

M211-20E-WH
M211-20E-BK

Colour
颜色

White/砂白色
Black/砂黑色

"L" Connector (Vertical Direction) / L型接驳器 (垂直方向)

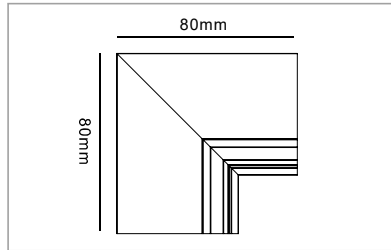

Model No.
产品型号

M212-20E-WH
M212-20E-BK

Colour
颜色

White/砂白色
Black/砂黑色

Installation / 安装说明

Fix
固定方式

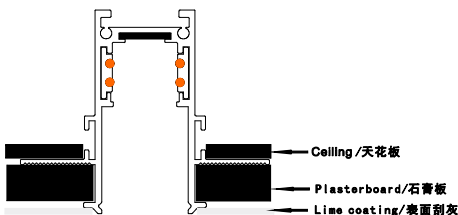

Magnet Track hole dimensions
磁吸轨道冲孔位置图

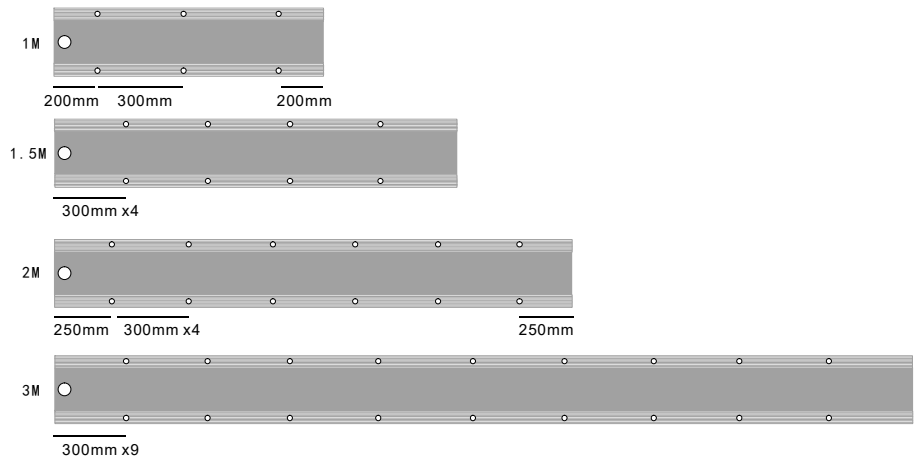

M20 Low Voltage Magnet Track System / M20 低压磁吸轨道系统

M20 Magnet Track Adaptor (Small) / M20短款磁吸轨道电器盒(带牙节)

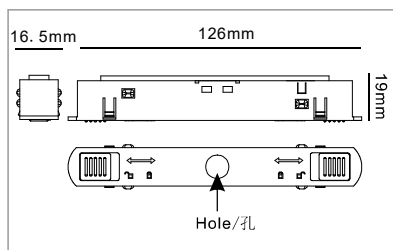

Model No.
产品型号

Colour
颜色

M105-WH
M105-BK

White/白色
Black/黑色

Excl Driver, For Spot Light
不含驱动, 连接轨道射灯用

M20 Magnet Track Adaptor (Small) / M20短款磁吸轨道电器盒(3孔)

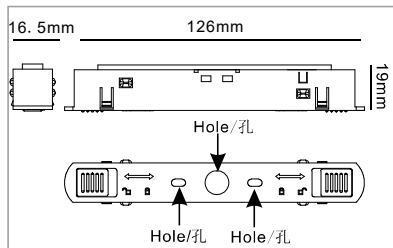

Model No.
产品型号

Colour
颜色

M106-WH
M106-BK

White/白色
Black/黑色

Excl Driver, For Track Linear and Grille Fixture
不含驱动, 连接轨道线条灯和格栅灯具用

M20 Magnet Track Adaptor (Long) / M20长款磁吸轨道电器盒(带牙节)

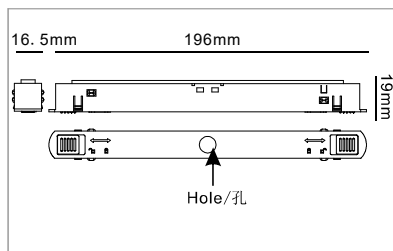

Model No.
产品型号

Colour
颜色

M207-WH
M207-BK

White/白色
Black/黑色

Excl Driver, For Spot Light
不含驱动, 连接轨道射灯用

M20 Magnet Track Adaptor (Long) / M20长款磁吸轨道电器盒(3孔)

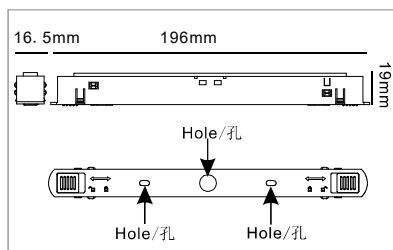

Model No.
产品型号

Colour
颜色

M208-WH
M208-BK

White/白色
Black/黑色

Excl Driver, For Track Linear and Grille Fixture
不含驱动, 连接轨道线条灯和格栅灯具用

M20 Low Voltage Magnet Track System / M20 低压磁吸轨道系统

Magnet Track Power Connector / 磁吸轨道电源头

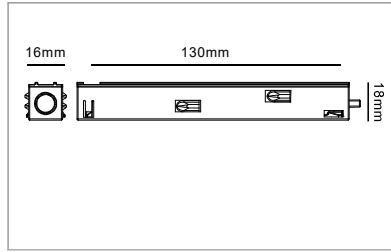

Model No.
产品型号

M311-WH
M311-BK

Colour
颜色

White/白色
Black/黑色

Magnet Track Power Connector (With wire) / 磁吸轨道电源头(带线)

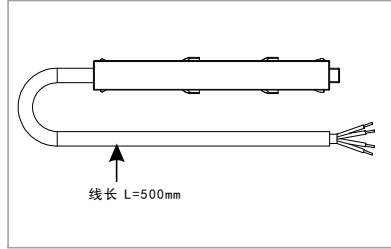

Model No.
产品型号

M312-WH
M312-BK

Colour
颜色

White/白色
Black/黑色

Magnet Track Power Connector (Dubble) / 磁吸轨道电源头(双头)

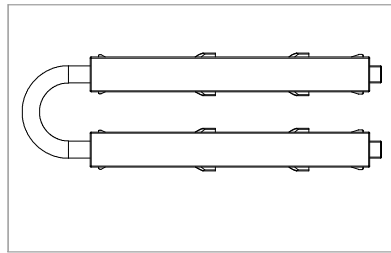

Model No.
产品型号

M313-WH
M313-BK

Colour
颜色

White/白色
Black/黑色

Magnet Track Joiner Connector / 磁吸轨道中间接驳器

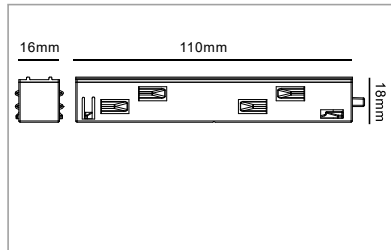

Model No.
产品型号

M316-WH
M316-BK

Colour
颜色

White/白色
Black/黑色

M20 Track End Cap / M20款磁吸轨道尾盖

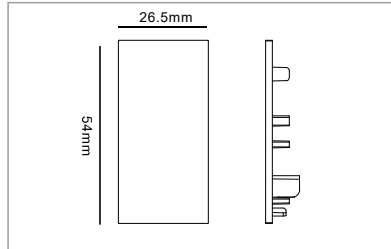
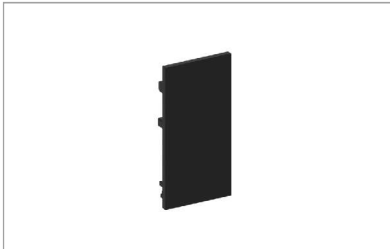

Model No.
产品型号

M317-WH
M317-BK

Colour
颜色

White/白色
Black/黑色

M20 Low Voltage Magnet Track System / M20 低压磁吸轨道系统

Magnet Track Suspension Kits / 磁吸轨道悬吊组件

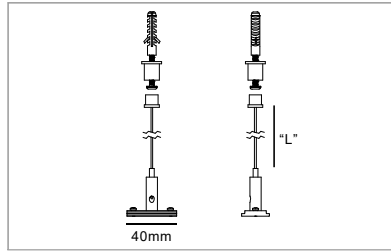

Model No.
产品型号

Colour
颜色

M391-WH
M391-BK

White/白色
Black/黑色

With $\phi 1.5\text{mm}$ L=1.5M Steel wire
带直径1.5mm 长度1.5M钢线

Magnet Track Connector Bracket / 磁吸轨道连接片

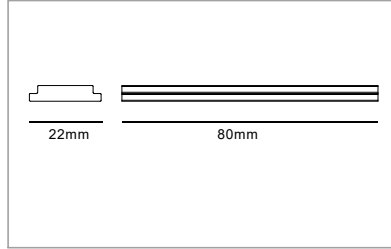

Model No.
产品型号

Colour
颜色

M392-WH
M392-BK

White/白色
Black/黑色

Magnet Track Dust Cover / 磁吸轨道防尘盖板

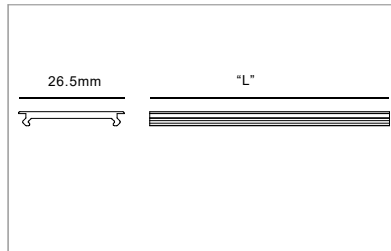

Model No.
产品型号

Colour
颜色

M393-WH
M393-BK

White/白色
Black/黑色

Track Suspension Diagram 轨道吊件安装图

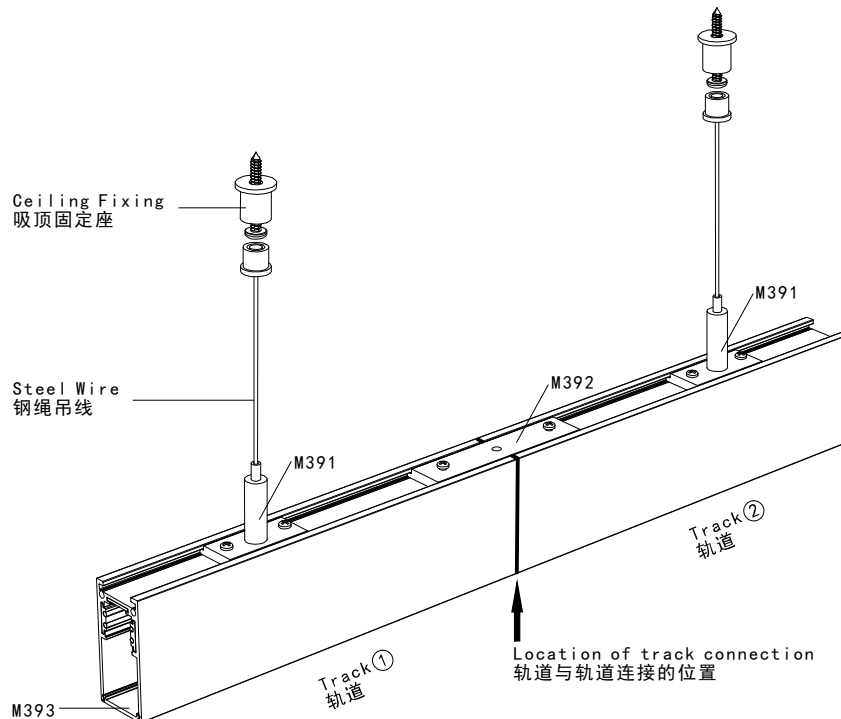

M20 Low Voltage Magnet Track System / M20 低压磁吸轨道系统

M20 Magnet Track Linear Lamp Kit (excl LED and Driver) with Small Adapter
M20 磁吸轨道泛光灯具套件(短款导轨头、不含LED和驱动器)

3D view of the lamp kit showing a black track with a white diffuser. The 2D view shows a total length of 305mm, a diffuser length of 120mm, a track height of 46mm, and a mounting hole offset of 23mm.

Model No. 产品型号	Diffuser Length 发光面长度	Colour 颜色
MS20-300-W	L=300mm	White/白色
MS20-300-B	L=300mm	Black/黑色

3D view of the lamp kit showing a black track with a white diffuser. The 2D view shows a total length of 605mm, a diffuser length of 120mm, a track height of 46mm, and a mounting hole offset of 23mm.

Model No. 产品型号	Diffuser Length 发光面长度	Colour 颜色
MS20-600-W	L=600mm	White/白色
MS20-600-B	L=600mm	Black/黑色

3D view of the lamp kit showing a black track with a white diffuser. The 2D view shows a total length of 905mm, a diffuser length of 120mm, a track height of 46mm, and a mounting hole offset of 23mm.

Model No. 产品型号	Diffuser Length 发光面长度	Colour 颜色
MS20-900-W	L=900mm	White/白色
MS20-900-B	L=900mm	Black/黑色

M20 Magnet Track Linear Lamp Kit (excl LED and Driver) with Long Adapter
M20 磁吸轨道泛光灯具套件(长款导轨头、不含LED和驱动器)

3D view of the lamp kit showing a black track with a white diffuser. The 2D view shows a total length of 305mm, a diffuser length of 165mm, a track height of 46mm, and a mounting hole offset of 23mm.

Model No. 产品型号	Diffuser Length 发光面长度	Colour 颜色
ML20-300-W	L=300mm	White/白色
ML20-300-B	L=300mm	Black/黑色

3D view of the lamp kit showing a black track with a white diffuser. The 2D view shows a total length of 605mm, a diffuser length of 165mm, a track height of 46mm, and a mounting hole offset of 23mm.

Model No. 产品型号	Diffuser Length 发光面长度	Colour 颜色
ML20-600-W	L=600mm	White/白色
ML20-600-B	L=600mm	Black/黑色

3D view of the lamp kit showing a black track with a white diffuser. The 2D view shows a total length of 905mm, a diffuser length of 165mm, a track height of 46mm, and a mounting hole offset of 23mm.

Model No. 产品型号	Diffuser Length 发光面长度	Colour 颜色
ML20-900-W	L=900mm	White/白色
ML20-900-B	L=900mm	Black/黑色

M20 Low Voltage Magnet Track System / M20 低压磁吸轨道系统

M20 Magnet Track Grille Lamp Kit (Excl LED and Driver) with Small Adapter
M20 磁吸轨道格栅灯具套件 (短款导轨头、不含LED和驱动器)

Model No. 产品型号	Beam Angle 发光角度	Colour 颜色
MS20-06G-24-W	24	White/白色
MS20-06G-50-W	50	White/白色
MS20-06G-24-B	24	Black/黑色
MS20-06G-50-B	50	Black/黑色

Model No. 产品型号	Beam Angle 发光角度	Colour 颜色
MS20-12G-24-W	24	White/白色
MS20-12G-50-W	50	White/白色
MS20-12G-24-B	24	Black/黑色
MS20-12G-50-B	50	Black/黑色

Model No. 产品型号	Beam Angle 发光角度	Colour 颜色
MS20-18G-24-W	24	White/白色
MS20-18G-50-W	50	White/白色
MS20-18G-24-B	24	Black/黑色
MS20-18G-50-B	50	Black/黑色

M20 Magnet Track Grille Lamp Kit (Excl LED and Driver) with Long Adapter
M20 磁吸轨道格栅灯具套件 (长款导轨头、不含LED和驱动器)

Model No. 产品型号	Beam Angle 发光角度	Colour 颜色
ML20-06G-24-W	24	White/白色
ML20-06G-50-W	50	White/白色
ML20-06G-24-B	24	Black/黑色
ML20-06G-50-B	50	Black/黑色

Model No. 产品型号	Beam Angle 发光角度	Colour 颜色
ML20-12G-24-W	24	White/白色
ML20-12G-50-W	50	White/白色
ML20-12G-24-B	24	Black/黑色
ML20-12G-50-B	50	Black/黑色

Model No. 产品型号	Beam Angle 发光角度	Colour 颜色
ML20-18G-24-W	24	White/白色
ML20-18G-50-W	50	White/白色
ML20-18G-24-B	24	Black/黑色
ML20-18G-50-B	50	Black/黑色

Extrusion Workshop



Lighting Track Production



Accessories Assembly



Finished Warehouse



THANK YOU

Nelux (HK) International.Ltd - KHUN lighting track -

Address Head Office
18 harbour road, central plaza
32/F 3208 office, wanchai, HK

Address Assembling Workshop
22 Kin Fat St. 11th Floor, Sun Hing Industrial Building,
Tuen Mun, Hong Kong, China

NELUX group
www.nelux.com.hk
www.solucionled.com

Contact	Call +852 28600042
Email	salesnelux@gmail.com
Skype.	neluxlighting